

FD70FN1HX



Product Family	Refrigerator
Installation	Free Standing
Category	Double Door
Reference width	60 - 70
Sistema Total No - Frost	Total
Cooling type	Total sem geadá - Sistema de arrefecimento duplo
Defrost	Automatic
Hinge type	Standard
Door opening flush with the wall	No
Slot-in	Yes
Hinge position	Right
Reversible door	Yes
EAN code	8017709295981



Aesthetics



Aesthetic	Universal	Handle colour	Silver
Colour	Stainless steel	Logo colour	Chrome
Acabamento	Anti-dedadas	Side material	Steel
Design	Flat	Side colour	Silver
Material	Stainless steel	Logotipo	Logotipo aplicado
Door steel type	Finger proof	Display	No
Handle kit to be ordered separately	No	Dispenser	No
Handle	External	Water Filter	No
Handle type	Fixed	HomeBar	No

Refrigerator compartment features



No. of adjustable shelves	2	Bottle shelf	No
Number of fruit and vegetables drawers	2	Type of crisper/vegetable drawers cover	Glass
Type of adjustable shelves	Glass	Life Plus zone-0°C	Yes
Type of crisper/vegetable drawers cover	Standard	Internal light in fridge	Yes
Crisper Cover	Yes	Type of internal light (fridge)	LED

Refrigerator Inner Door

Number of adjustable door shelves	3	No. of bottle shelves	1
Adjustable door shelves with wire support	No	Bottle shelves with wire support	No

Other Refrigerator features



Accessories	Cheese box, Egg tray	MultiFlow Fan	Yes
Natural Plus Blu Light	No		Yes

Freezer compartment features

No. of shelves	1	Type of internal light (freezer)	LED
Internal light in freezer	No	Type of shelves	Glass

Freezer Inner Door

No. of adjustable door shelves	2	Pizza box	No
---------------------------------------	---	------------------	----

Other Freezer features

Manual ice maker	Yes	Fast freezing compartment	No
Ice maker	Manual	Ice tray shelf	No

Other technical features

MultiZone	No
Fast freezing button	No
Power on lamp	No
Temperature alarm lamp	No
Door open alarm	No
Temperature Alarm	No
Antibacterial Gasket	No
Type of temperature control	Electro-mechanical
No. of compressors	1
Refrigerant gas type	R600a
Type of compressor	Standard
Refrigerant Quantity (gr)	61 g
Espuma expansiva de isolamento	Ciclopentano

Etiqueta de Desempenho / Energia - Reg. 2019









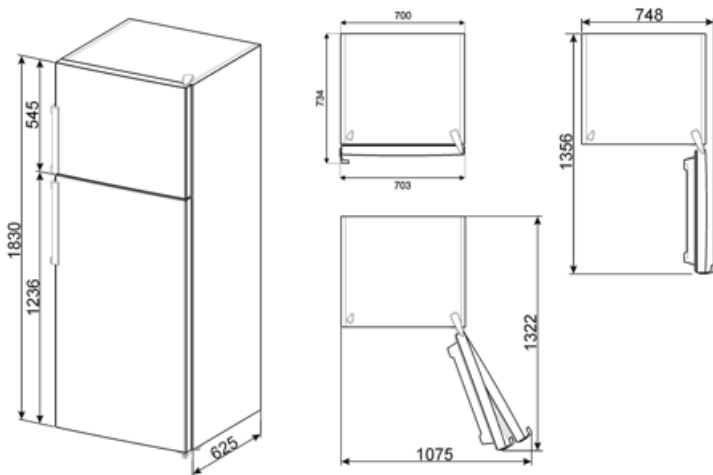



Consumo de energia anual	311 kWh/a	Airborne acoustical noise emissions	41 dB(A) re 1 pW
Classe de eficiência energética	F	Autonomia de conservação sem energia elétrica	13.28 h
Classe de emissão de ruído acústico aerotransportado	C	4 estrelas - Capacidade de congelamento	7.0 Kg/24h
Volume líquido total	434 l	Classe climática	SN, T
Soma dos volumes do(s) compartimento(s) congelado(s)	98 l	EI	125 %
Soma dos volumes do(s) compartimento(s) refrigerado(s) e do(s) compartimento(s) não congelado(s)	337 l		

Electrical Connection

Plug	(F;E) Schuko	Voltage (V)	220-240 V
Electrical connection rating	200 W	Frequency (Hz)	50 Hz
Current	1,39 A	Power supply cable length	210 cm



Symbols glossary

	Compartimento de congelamento de 4 estrelas para uma melhor preservação dos alimentos.		O sistema de descongelamento automático funciona descongelando automaticamente em intervalos regulares, eliminando a necessidade de descongelar completamente.
	A+: A classe de eficiência energética A+ ajuda a economizar até 10% de energia em comparação com a classe A. O desempenho máximo com consumo mínimo é garantido.		Classe de eficiência energética F
	Ventilado: Distribuição forçada de ar frio no compartimento da geladeira, o que permite uma distribuição uniforme da temperatura dentro da geladeira.		Aço inoxidável à prova de dedadas: O aço inoxidável à prova de dedadas mantém o aço inoxidável com um aspeto novo.
	Iluminação interior LED: é uma forma mais eficiente em termos energéticos e duradoura de iluminar o interior do aparelho.		Life Plus 0°C: A temperatura nos compartimentos Lifeplus é mantida a 0°C, o que preserva a carne fresca e o peixe por mais tempo.
	Ar mais: mantém a comida mais fresca por mais tempo.		Slot-in: As geladeiras com abertura Slot-in podem ser perfeitamente integrados na estrutura do mobiliário, uma vez que as portas abertas a 90° não vão além do lado do produto. Em caso de instalação ao lado da parede, será necessário considerar as dimensões do puxador para abrir a porta a 90°.

Benefit (TT)

No-Frost system

The No Frost system prevents the formation of ice and contributes to better preservation of food in the refrigerator

Plastic multiflow system

The Multiflow system ensures even distribution of cold air inside the refrigerator

Fan

The fan contributes to an even distribution of air inside the refrigerator

Refrigerant gas R600a

Environmentally friendly R600a refrigerant gas contributes to rapid cooling with lower energy consumption

Climate class

Climatic class SN-T makes the appliance suitable for working at room temperature between 10 °C and 43 °C (50 °F ~ 109 °F)

External handle

The external handle ensures practicality and ease of use of the refrigerator

Life Plus 0°

Temperature-controlled Life Plus compartment for optimal storage of specific food categories

Refrigerator Internal lighting

Interior lighting for perfect visibility of shelves in the refrigerator compartment

Fruit and vegetable drawer

The fruit and vegetable drawer ensures the best storage conditions for fresh food, avoiding any contamination

Manual Ice Maker

Manual ice maker to manually adjust the amount of ice produced according to personal requirements