

FMI017X

Usable volume

17 l



Product Family

Microwave

Category

Built-in

Installation

With frame

Power supply

Electric

Cooking Method

Microwave with grill

Control

Electromechanical



Controls

Display / Clock

1 a LED

Type of control setting

Control knobs / buttons

Opening

Mechanical button

No. of controls

1

Control knobs

Push-push

Controls colour

Steel effect

Buttons Colour

Steel effect

Options



Timer

Electronic

Time-setting options

End cooking

End of cooking acoustic alarm

Yes

Controls Lock / Child Safety

Yes

Quick start option

Yes

Technical Features



Cavity material

Stainless steel

No. of lights

1

Light type

Led

Turntable

Yes

Turntable dimensions

24.5 cm

Light when door is opened

Yes

Grill type

Quartz

Grill - power

1000 W

Door opening

Side-opening

Total no. of door glasses

1

Safety Thermostat

Yes

Cooling system

Tangential

Microwave screen protection

Yes

Microwave stops when door is opened

Yes

Usable cavity space dimensions (HxWxD)

194x330x290 mm

Microwave effective power 700 W

Accessories Included







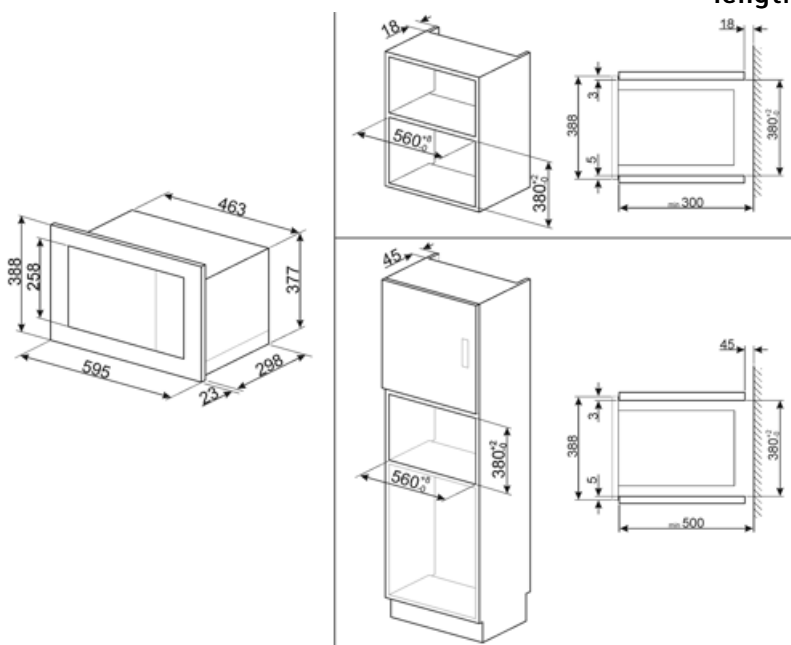



Grid 1 Frame Yes

Electrical Connection

Plug Not present Voltage (V) 230 V
 Nominal power 1050 W Frequency (Hz) 50 Hz
 Current 4,5 A Power supply cable length 100 cm



Symbols glossary

	Child lock: some models are fitted with a device to lock the programme/cycle so it cannot be accidentally changed.		Microwave energy shortens cooking times dramatically and produces energy savings.
	Defrost by time: Manual defrost function. At the end of the set duration, the function stops.		Defrost by weight: Automatic defrost function. You choose the type of food to defrost from the available categories (MEAT - FISH - BREAD - DESSERTS) After entering the weight of the food, the oven automatically defines the time required for proper defrosting.
	Fingerprint proof stainless steel: Fingerprint proof stainless steel keeps stainless steel looking as good as new.		Grill: Very intense heat coming only from above from a double heating element. The fan is not active. Provides excellent grilling and gratinating results. Used at the end of cooking, it gives a uniform browning to dishes.
	Microwave: Penetrating straight into the food, microwaves cook very quickly and with considerable energy savings. Suitable for cooking without fat, they are also able to thaw and heat food without altering its original appearance and aroma. The microwave function can also be combined with conventional functions with all the resulting advantages. Ideal for all types of food.		Microwave + grill element: The use of the grill results in a perfect browning of the surface of the food. The action of microwaves allows instead of cooking in a short time the internal part of the food.
	Side lights: Two opposing side lights increase visibility inside the oven.		The capacity indicates the amount of usable space in the oven cavity in litres.

Benefit (TT)

Automatic programmes

Preset programmes to simplify use and improve efficiency

Child control lock

Thanks to the child safety lock, the microwave provides peace of mind for parents while improving overall safety in the home environment

Quick start

One-touch cooking and heating start-up with the Quick Start option for a simple and intuitive user experience