

FMI020X



Product Family	Microwave
Category	Built-in
Installation type	Built-in
Installation	With frame
Power supply	Electric
Cooking Method	Microwave with grill
Control	Electromechanical



Aesthetics

Aesthetic	Universale	Type of steel	Brushed
Colour	Stainless steel	Serigraphy colour	Black
Finishing	Fingerproof	Door	With panel
Frame	Yes	Handle Colour	Steel effect
Material	Stainless steel	Logo	Embossed

Program / Functions



No. of functions	5	Microwave	Yes
Full grill	Yes	Microwave + grill	Yes
Defrost by time	Yes	Automatic programmes	8
Defrost by weight	Yes	Other Microwave functions	Multi-session cooking

Controls

Display / Clock	1 a LED	Control knobs	Push-push
Type of control setting	Control knobs / buttons	Controls colour	Steel effect
Opening	Mechanical button	Buttons Colour	Steel effect
No. of controls	1		

Options



Timer	Electronic	Controls Lock / Child Safety	Yes
Time-setting options	End cooking	Quick start option	Yes
End of cooking acoustic alarm	Yes		

Technical Features



Cavity material	Stainless steel	Door opening	Side-opening
No. of lights	1	Total no. of door glasses	1
Light type	Led	Safety Thermostat	Yes
Turntable	Yes	Cooling system	Tangential
Turntable dimensions	24,5 cm	Microwave screen protection	Yes
Light when door is opened	Yes	Microwave stops when door is opened	Yes
Grill type	Heating element	Usable cavity space dimensions (HxWxD)	218x315x295 mm
Grill - power	1000 W	Microwave effective power	800 W

Accessories included

Grid	1	Frame	Yes
------	---	-------	-----

Performance / Energy Label









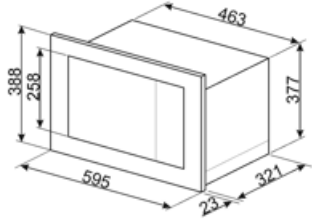



Usable volume	20 l	Gross volume	21 l
---------------	------	--------------	------

Electrical Connection

Plug	Not present	Voltage (V)	230 V
Nominal power	1250 W	Frequency (Hz)	50 Hz
Current	5,4 A	Power supply cable length	150 cm



Symbols glossary

- | | | | |
|--|---|---|--|
|  | Child lock: some models are fitted with a device to lock the programme/cycle so it cannot be accidentally changed. |  | Microwave energy shortens cooking times dramatically and produces energy savings. |
|  | Defrost by time: Manual defrost function. At the end of the set duration, the function stops. |  | Defrost by weight: Automatic defrost function. You choose the type of food to defrost from the available categories (MEAT - FISH - BREAD - DESSERTS). After entering the weight of the food, the oven automatically defines the time required for proper defrosting. |
|  | Fingerprint proof stainless steel: Fingerprint proof stainless steel keeps stainless steel looking as good as new. |  | Grill: Very intense heat coming only from above from a double heating element. The fan is not active. Provides excellent grilling and gratinating results. Used at the end of cooking, it gives a uniform browning to dishes. |
|  | Microwave + grill element: The use of the grill results in a perfect browning of the surface of the food. The action of microwaves allows instead of cooking in a short time the internal part of the food. |  | Microwave: Penetrating straight into the food, microwaves cook very quickly and with considerable energy savings. Suitable for cooking without fat, they are also able to thaw and heat food without altering its original appearance and aroma. The microwave function can also be combined with conventional functions with all the resulting advantages. Ideal for all types of food. |
|  | Side lights: Two opposing side lights increase visibility inside the oven. |  | The capacity indicates the amount of usable space in the oven cavity in litres. |