

# FMI120B2

Usable volume

20 l



Product Family

Microwave

Category

Built-in

Installation

With frame

Tipo de energia

Eléctrico

Tipo de cozimento

Microwave with grill

Control

Electronic



## Controls



Display / Clock

TFT

Opening

Electrical button

Type of control setting

Touch control

## Options



Timer

Electronic

Showroom demo option Yes

Time-setting options

End cooking

Controls Lock / Child Yes

End of cooking acoustic alarm

Yes

Safety

Limited Power

Yes

Stop turntable option No

Consumption Mode

Quick start option Yes

## Technical Features



Cavity material

Stainless steel

Tilting grill

No

No. of shelves/ levels

2

Grill - power

1000 W

Shelves type

Rack

Door opening

Side-opening

No. of lights

1

Full glass inner door

No

Light type

Incandescent

Total no. of door glasses

2

Light user replaceable

No

Safety Thermostat

No

Light Power

20 W

Cooling system

Tangential

Turntable

Yes

Microwave screen protection

Yes

Ceramic base	No	Microwave stops when door is opened	Yes
Turntable dimensions	24.5 cm	Inverter	No
Light when door is opened	Yes	Usable cavity space dimensions (HxWxD)	210x305x280 mm
Grill type	Quartz	Microwave effective power	800 W

## Accessories Included







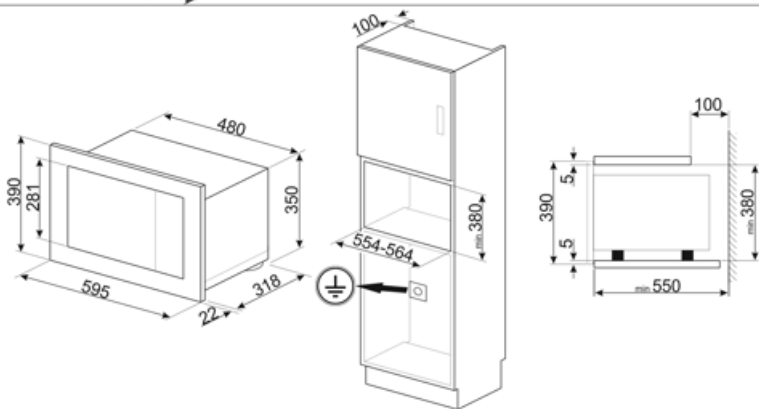
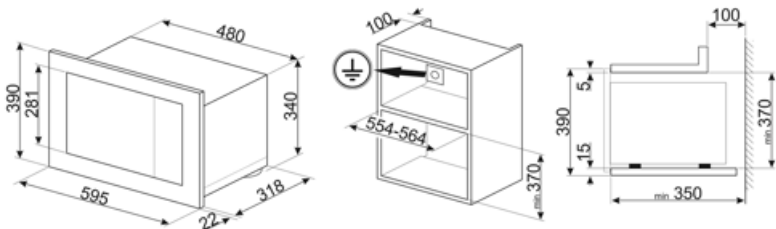



Grid	1	Frame	Yes
Other	No		

## Electrical Connection

Plug	No	Voltage (V)	230 V
Nominal power	1300 W	Frequency (Hz)	50 Hz
Current	5,2 A	Comprimento do cabo de alimentação	150 cm



## Symbols glossary

-  Bloqueio para crianças: alguns modelos estão equipados com um dispositivo para bloquear o programa/ciclo para que não possa ser acidentalmente alterado.
-  Descongelar pelo tempo: com esta função, o tempo de descongelamento dos alimentos é determinado automaticamente.
-  Portas de vidros duplos: Número de portas envidraçadas.
-  Micro-ondas Penetrando diretamente na comida, micro-ondas cozinham muito rapidamente e com considerável economia de energia. Adequados para cozinhar sem gordura, eles também são capazes de descongelar e aquecer alimentos sem alterar a sua aparência original e aroma. A função de micro-ondas também pode ser combinada com funções convencionais com todas as vantagens resultantes. Ideal para todos os tipos de alimentos.
-  O compartimento do forno tem 2 níveis de cozimento diferentes.
-  A capacidade indica a quantidade de espaço útil no compartimento do forno em litros.
-  A energia de micro-ondas encurta drasticamente os tempos de cozimento e produz economia de energia.
-  Descongelar pelo peso: Com esta função, o tempo de descongelamento é determinado
-  Elemento de grelha O uso de grelha dá excelentes resultados ao cozinhar carne de porções médias e pequenas, especialmente quando combinada com uma rotisseria (sempre que possível). Também é ideal para cozinhar salsichas e bacon.
-  Micro-ondas + elemento de grelha: O uso da grelha resulta em um perfeito escurecimento da superfície dos alimentos. A ação de micro-ondas permite em vez de cozinhar em pouco tempo a parte interna do alimento.
-  Controles táteis: O controles táteis, fáceis de usar, permitem que o aparelho seja programado com o toque de um botão.

## Benefit (TT)

---

### **Electronic control**

Timely temperature management and heat uniformity

### **Touch control**

Easy operation of the display and cooking by touch

### **Automatic programmes**

Preset programmes to simplify use and improve efficiency

### **Child control lock**

Thanks to the child safety lock, the microwave provides peace of mind for parents while improving overall safety in the home environment

### **Quick start**

One-touch cooking and heating start-up with the Quick Start option for a simple and intuitive user experience