

# FMI120G



<b>Product Family</b>	Microwave
<b>Category</b>	Built-in
<b>Installation type</b>	Built-in
<b>Installation</b>	With frame
<b>Power supply</b>	Electric
<b>Cooking Method</b>	Microwave with grill
<b>Control</b>	Electronic



## Aesthetics

<b>Aesthetics</b>	Linea	<b>Serigraphy colour</b>	Grey
<b>Colour</b>	Neptune Grey	<b>Door</b>	Full glass
<b>Frame</b>	Yes	<b>Logo</b>	Silk screen
<b>Material</b>	Glass		

## Program / Functions



<b>No. of functions</b>	5	<b>Microwave</b>	Yes
<b>Full grill</b>	Yes	<b>Microwave + grill</b>	Yes
<b>Defrost by time</b>	Yes	<b>Automatic programmes</b>	3
<b>Defrost by weight</b>	Yes	<b>Other Microwave functions</b>	Memory

## Controls

	<b>Display / Clock</b>	TFT	<b>Opening</b>	Electrical button
	<b>Type of control setting</b>	Touch control		

## Options

	<b>Timer</b>	Electronic	<b>Showroom demo option</b>	Yes
--	--------------	------------	-----------------------------	-----

Time-setting options	End cooking	Controls Lock / Child Safety	Yes
End of cooking acoustic alarm	Yes	Quick start option	Yes
Limited Power Consumption Mode	Yes		

## Technical Features

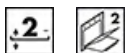

Cavity material	Stainless steel	Grill - power	1000 W
Shelf positions	2	Door opening	Side-opening
Shelves type	Rack	Total no. of door glasses	2
No. of lights	1	Cooling system	Tangential
Light type	Incandescent	Microwave screen protection	Yes
Light power	20 W	Microwave stops when door is opened	Yes
Turntable	Yes	Usable cavity space dimensions (HxWxD)	210x305x280 mm
Turntable dimensions	24,5 cm	Microwave effective power	800 W
Grill type	Quartz		

## Accessories Included

Grid	1	Frame	Yes
------	---	-------	-----

## Performance / Energy Label



Usable volume	20 l	Gross volume	21 l
---------------	------	--------------	------

## Electrical Connection

Plug	No	Voltage (V)	230 V
Nominal power (W)	1300 W	Frequency (Hz)	50 Hz
Current	5,2 A	Power supply cable length	150 cm

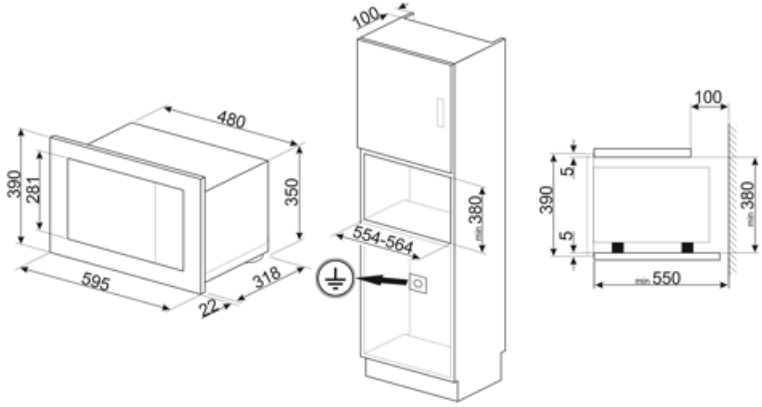

---

## Alternative products











---

**FMI120B3**

**Colour: Black**



## Symbols glossary

- |  |  |   |   |
|--|--|---|---|
|    | Child lock: some models are fitted with a device to lock the programme/cycle so it cannot be accidentally changed.   |    | Microwave energy shortens cooking times dramatically and produces energy savings.   |
|    | Defrost by time: with this function the time of thawing of foods are determined automatically.   |    | Defrost by weight: With this function the defrosting time is determined   |
|    | Double glazed doors: Number of glazed doors.   |    | Grill element: Using of grill gives excellent results when cooking meat of medium and small portions, especially when combined with a rotisserie (where possible). Also ideal for cooking sausages and bacon. |
|    | Microwave: Penetrating straight into the food, microwaves cook very quickly and with considerable energy savings. Suitable for cooking without fat, they are also able to thaw and heat food without altering its original appearance and aroma. The microwave function can also be combined with conventional functions with all the resulting advantages. Ideal for all types of food. |    | Microwave + grill element: The use of the grill results in a perfect browning of the surface of the food. The action of microwaves allows instead of cooking in a short time the internal part of the food.   |
|  | The oven cavity has 2 different cooking levels.  |  | Touch controls: Easy to use touch controls allow the appliance to be programmed at the touch of a button.   |
|  | The capacity indicates the amount of usable space in the oven cavity in litres.  |   |   |