

# FMI120N2

Usable volume

20 l



Product Family

Microwave

Category

Built-in

Installation

With frame

Power supply

Electric

Cooking Method

Microwave with grill

Control

Electronic



## Programs / Functions

No. of functions

5

Full grill



Defrost by time



Defrost by weight



Microwave



Microwave + grill



Automatic programmes

3

Other Microwave functions

Memory

## Controls



Display / Clock

TFT

Opening

Electrical button

Type of control setting

Touch control

## Options



Timer

Electronic

Showroom demo option Yes

Time-setting options

End cooking

Controls Lock / Child Yes

End of cooking acoustic alarm

Yes

Safety

Quick start option Yes

Limited Power Consumption Mode Yes

## Technical Features

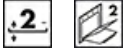

Cavity material	Stainless steel	Grill type	Quartz
Shelf positions	2	Grill - power	1000 W
Shelves type	Rack	Door opening	Side-opening
No. of lights	1	Total no. of door glasses	2
Light type	Incandescent	Cooling system	Tangential
Light power	20 W	Microwave screen protection	Yes
Turntable	Yes	Microwave stops when door is opened	Yes
Turntable dimensions	24,5 cm	Usable cavity space dimensions (HxWxD)	210x305x280 mm
Light when door is opened	Yes	Microwave effective power	800 W

## Accessories Included

Grid 1 Frame Yes

## Electrical Connection

Nominal power (W)	1300 W	Frequency (Hz)	50 Hz
Current	5.2 A	Power supply cable length	150 cm
Voltage (V)	230 V		

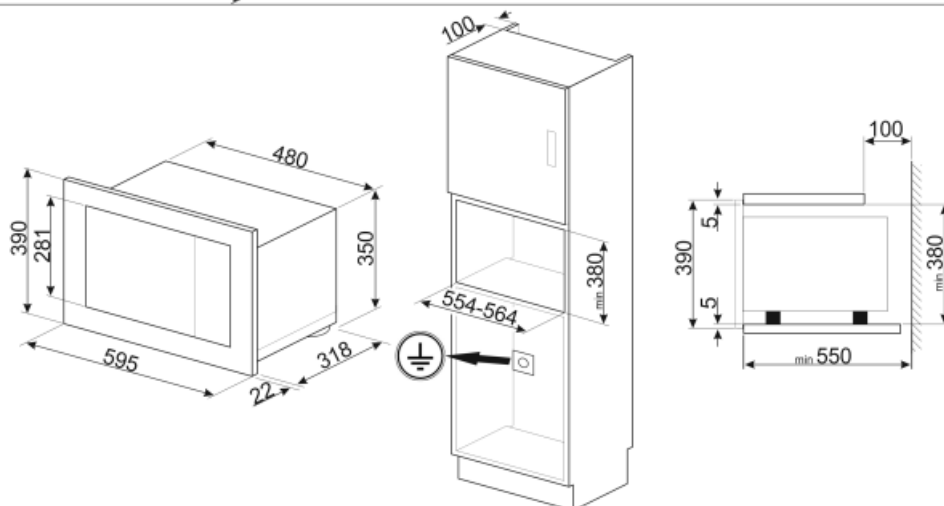
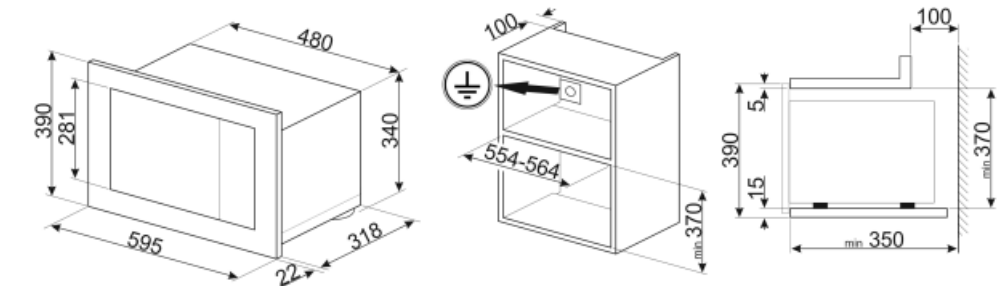

## Not included accessories

---

### KITPLATE













The dish baker is a Teflon-coated aluminum plate with the lower part of ferrous material immersed in a silicone rubber 26,5 cm edges of the flare, 25 cm base

---

## Symbols glossary

---

- |  |  |   |   |
|--|--|---|---|
|    | Child lock: some models are fitted with a device to lock the programme/cycle so it cannot be accidentally changed.   |    | Microwave energy shortens cooking times dramatically and produces energy savings.   |
|    | Defrost by time: with this function the time of thawing of foods are determined automatically.   |    | Defrost by weight: With this function the defrosting time is determined   |
|    | Double glazed doors: Number of glazed doors.   |    | Grill element: Using of grill gives excellent results when cooking meat of medium and small portions, especially when combined with a rotisserie (where possible). Also ideal for cooking sausages and bacon. |
|    | Microwave: Penetrating straight into the food, microwaves cook very quickly and with considerable energy savings. Suitable for cooking without fat, they are also able to thaw and heat food without altering its original appearance and aroma. The microwave function can also be combined with conventional functions with all the resulting advantages. Ideal for all types of food. |    | Microwave + grill element: The use of the grill results in a perfect browning of the surface of the food. The action of microwaves allows instead of cooking in a short time the internal part of the food.   |
|  | The oven cavity has 2 different cooking levels.  |  | Touch controls: Easy to use touch controls allow the appliance to be programmed at the touch of a button.   |
|  | The capacity indicates the amount of usable space in the oven cavity in litres.  |   |   |