

FMI120N2

Bruikbare inhoud

20 l



Familie

Magnetron

Categorie

Inbouw

Installatie

Met frame

Voeding

Elektrisch

Bereidingswijze

Magnetron met grill

Bediening

Elektronisch



Programma's / functies

Aantal functies

5

Grote vlakgrill



Ontdooien op tijd



Ontdooien op gewicht



Magnetron



Magnetron + grill



Automatische programma's

D

Overige functies magnetron

Memory

Bediening



Display / Klok

TFT

Opening

Electrical button

Type bediening

Touch control

Opties



Timer

Elektronisch

Showroom demo optie

Ja

Opties

Eind

Kinderbeveiliging

Ja

tijdprogrammering

Quick Start optie

Ja

Akoestisch signaal
einde kooktijd

Ja

ECO-Logic optie Ja

Technische specificaties



Materiaal ovenruimte	RVS	Type grill	Kwarts
Aantal kookniveaus	2	Grill - vermogen	1000 W
Type ovenrekken	Verhoogd rooster	Deur openen	Side-opening
Aantal lampen	1	Totaal aantal ruiten	2
Soort verlichting	Gloeilamp	Koelsysteem	Mantelkoeling
Vermogen lamp	20 W	Veiligheidsscherm magnetrondeur	Ja
Draaiplateau	Ja	Automatische uitschakeling magnetron bij openen deur	Ja
Afmetingen draaiplateau	24,5 cm	Afmetingen bruikbare interne ovenruimte (hxbxd)	210x305x280 mm
Automatische inschakeling verlichting bij openen deur	Ja	Effectief magnetronvermogen	800 W

Meegeleverde accessoires

Ovenrooster 1 Kader Ja

Elektrische aansluiting

Aansluitwaarde	1300 W	Frequentie (Hz)	50 Hz
Stroom	5.2 A	Lengte voedingskabel	150 cm
Spanning (V)	230 V		

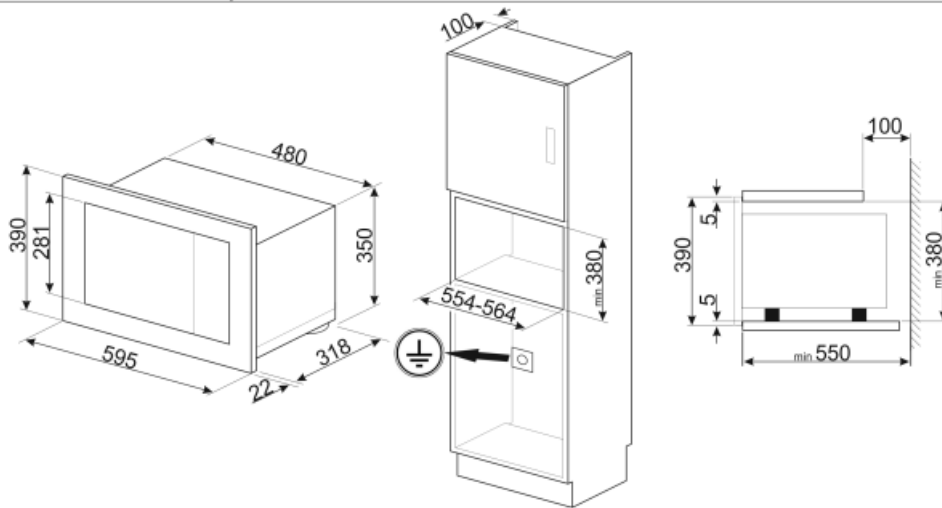
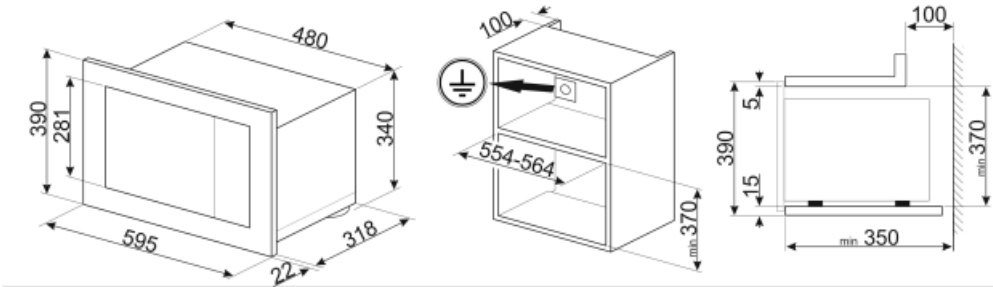











Accessoires niet inbegrepen

KITPLATE



The dish baker is a Teflon-coated aluminum plate with the lower part of ferrous material immersed in a silicone rubber 26,5 cm edges of the flare, 25 cm base

Symbols glossary (TT)

- | | | | |
|--|--|---|--|
|  | Kinderslot: sommige modellen zijn voorzien van een apparaat om het programma / de cyclus te vergrendelen zodat het niet kan per ongeluk veranderd |  | Microwave energy shortens cooking times dramatically and produces energy savings. |
|  | Ontdooien op tijd: met deze functie wordt automatisch het tijdstip van ontdooien van voedsel bepaald |  | Ontdooien op gewicht: Met deze functie wordt de ontdooitijd bepaald |
|  | Dubbele beglazing: aantal glazen deuren. |  | De warmte wordt geproduceerd door het grill- en bovenelement. Verhitting over het volledige oppervlak. De thermostaat wordt, afhankelijk van het gerecht, in de regel op de maximale stand gezet. Bij een korte baktijd kan de ovendeur gesloten blijven; bij langere baktijd blijft deze gedeeltelijk geopend. Voor vleesgerechten (klein- en middelgroot), vleespennen, vis, groenten, gratineren etc. |
|  | Microwave: Penetrating straight into the food, microwaves cook very quickly and with considerable energy savings. Suitable for cooking without fat, they are also able to thaw and heat food without altering its original appearance and aroma. The microwave function can also be combined with conventional functions with all the resulting advantages. Ideal for all types of food. |  | Microwave + grill element: The use of the grill results in a perfect browning of the surface of the food. The action of microwaves allows instead of cooking in a short time the internal part of the food. |
|  | The oven cavity has 2 different cooking levels. |  | Touch control: dankzij de gebruiksvriendelijke Touch control kan het apparaat met één druk op de knop worden geprogrammeerd. |
|  | The capacity indicates the amount of usable space in the oven cavity in litres. | | |