

FMI120N2

Usable volume	20 l
	
Product Family	Microwave
Category	Built-in
Installation	With frame
Tipo de energia	Eléctrico
Tipo de cozimento	Microwave with grill
Control	Electronic





Controls

			
Display / Clock	TFT	Opening	Electrical button
Type of control setting	Touch control		

Options

			
Timer	Electronic	Showroom demo option	Yes
Time-setting options	End cooking	Controls Lock / Child Safety	Yes
End of cooking acoustic alarm	Yes	Stop turntable option	No
Limited Power Consumption Mode	Yes	Quick start option	Yes

Technical Features

			
Cavity material	Stainless steel	Tilting grill	No
No. of shelves/ levels	2	Grill - power	1000 W
Shelves type	Rack	Door opening	Side-opening
No. of lights	1	Full glass inner door	No
Light type	Incandescent	Total no. of door glasses	2
Light user replaceable	No	Safety Thermostat	No
Light Power	20 W	Cooling system	Tangential
Turntable	Yes	Microwave screen protection	Yes

Ceramic base	No	Microwave stops when door is opened	Yes
Turntable dimensions	24.5 cm	Inverter	No
Light when door is opened	Yes	Usable cavity space dimensions (HxWxD)	210x305x280 mm
Grill type	Quartz	Microwave effective power	800 W

Accessories Included







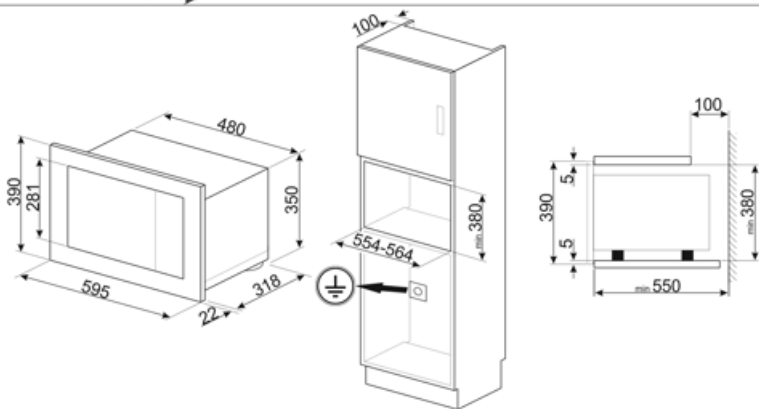
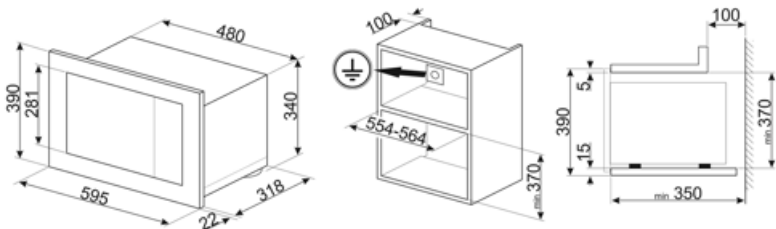



Grid	1	Frame	Yes
Other	No		

Electrical Connection

Plug	No	Voltage (V)	230 V
Nominal power	1300 W	Frequency (Hz)	50 Hz
Current	5,2 A	Comprimento do cabo de alimentação	150 cm



Symbols glossary

-  Bloqueio para crianças: alguns modelos estão equipados com um dispositivo para bloquear o programa/ciclo para que não possa ser acidentalmente alterado.
-  Descongelar pelo tempo: com esta função, o tempo de descongelamento dos alimentos é determinado automaticamente.
-  Portas de vidros duplos: Número de portas envidraçadas.
-  Micro-ondas Penetrando diretamente na comida, micro-ondas cozinham muito rapidamente e com considerável economia de energia. Adequados para cozinhar sem gordura, eles também são capazes de descongelar e aquecer alimentos sem alterar a sua aparência original e aroma. A função de micro-ondas também pode ser combinada com funções convencionais com todas as vantagens resultantes. Ideal para todos os tipos de alimentos.
-  O compartimento do forno tem 2 níveis de cozimento diferentes.
-  A capacidade indica a quantidade de espaço útil no compartimento do forno em litros.
-  A energia de micro-ondas encurta drasticamente os tempos de cozimento e produz economia de energia.
-  Descongelar pelo peso: Com esta função, o tempo de descongelamento é determinado
-  Elemento de grelha O uso de grelha dá excelentes resultados ao cozinhar carne de porções médias e pequenas, especialmente quando combinada com uma rotisseria (sempre que possível). Também é ideal para cozinhar salsichas e bacon.
-  Micro-ondas + elemento de grelha: O uso da grelha resulta em um perfeito escurecimento da superfície dos alimentos. A ação de micro-ondas permite em vez de cozinhar em pouco tempo a parte interna do alimento.
-  Controles táteis: O controles táteis, fáceis de usar, permitem que o aparelho seja programado com o toque de um botão.

Benefit (TT)

Electronic control

Timely temperature management and heat uniformity

Touch control

Easy operation of the display and cooking by touch

Automatic programmes

Preset programmes to simplify use and improve efficiency

Child control lock

Thanks to the child safety lock, the microwave provides peace of mind for parents while improving overall safety in the home environment

Quick start

One-touch cooking and heating start-up with the Quick Start option for a simple and intuitive user experience