







FMI120S2

Usable volume	20 l
	
Product Family	Microwave
Category	Built-in
Installation	With frame
Power supply	Electric
Cooking Method	Microwave with grill
Control	Electronic



Programs / Functions

No. of functions	5
Full grill	
Defrost by time	
Defrost by weight	
Microwave	
Microwave + grill	
Automatic programmes	3
Other Microwave functions	Memory

Controls

	Display / Clock	TFT	Opening	Electrical button
	Type of control setting	Touch control		

Options

	Timer	Electronic	Showroom demo option	Yes
	Time-setting options	End cooking	Controls Lock / Child Safety	Yes
	End of cooking acoustic alarm	Yes	Quick start option	Yes

Limited Power Consumption Mode Yes

Technical Features



Cavity material	Stainless steel	Grill type	Quartz
Shelf positions	2	Grill - power	1000 W
Shelves type	Rack	Door opening	Side-opening
No. of lights	1	Total no. of door glasses	2
Light type	Incandescent	Cooling system	Tangential
Light power	20 W	Microwave screen protection	Yes
Turntable	Yes	Microwave stops when door is opened	Yes
Turntable dimensions	24,5 cm	Usable cavity space dimensions (HxWxD)	210x305x280 mm
Light when door is opened	Yes	Microwave effective power	800 W

Accessories Included

Grid 1 Frame Yes

Electrical Connection

Nominal power (W)	1300 W	Frequency (Hz)	50 Hz
Current	5.2 A	Power supply cable length	150 cm
Voltage (V)	230 V		

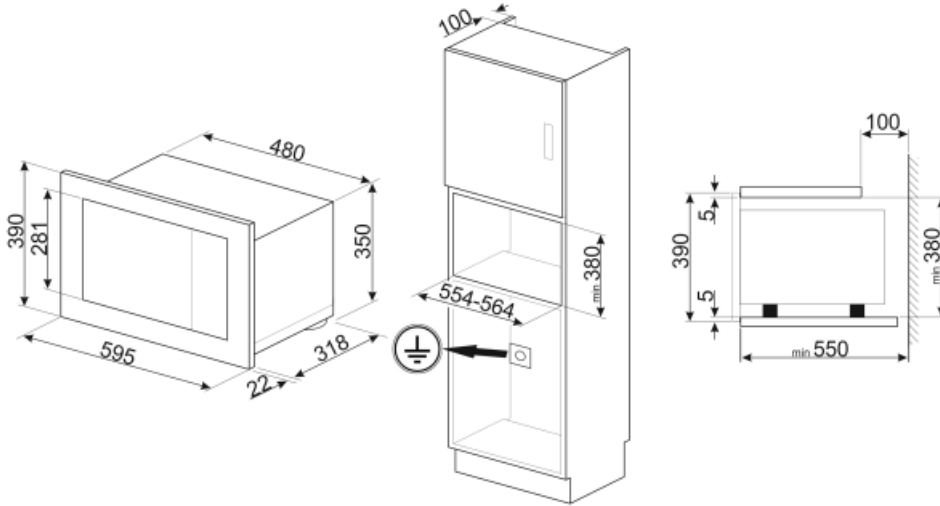
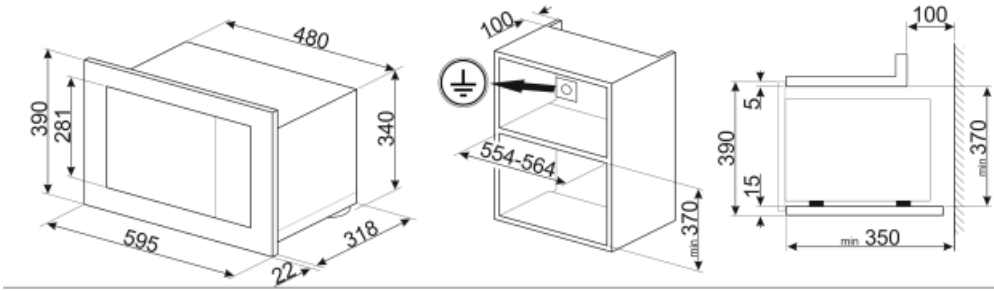











Not included accessories

KITPLATE



The dish baker is a Teflon-coated aluminum plate with the lower part of ferrous material immersed in a silicone rubber 26,5 cm edges of the flare, 25 cm base

Symbols glossary

- | | | | |
|--|--|---|---|
|  | Child lock: some models are fitted with a device to lock the programme/cycle so it cannot be accidentally changed. |  | Microwave energy shortens cooking times dramatically and produces energy savings. |
|  | Defrost by time: with this function the time of thawing of foods are determined automatically. |  | Defrost by weight: With this function the defrosting time is determined |
|  | Double glazed doors: Number of glazed doors. |  | Grill element: Using of grill gives excellent results when cooking meat of medium and small portions, especially when combined with a rotisserie (where possible). Also ideal for cooking sausages and bacon. |
|  | Microwave: Penetrating straight into the food, microwaves cook very quickly and with considerable energy savings. Suitable for cooking without fat, they are also able to thaw and heat food without altering its original appearance and aroma. The microwave function can also be combined with conventional functions with all the resulting advantages. Ideal for all types of food. |  | Microwave + grill element: The use of the grill results in a perfect browning of the surface of the food. The action of microwaves allows instead of cooking in a short time the internal part of the food. |
|  | The oven cavity has 2 different cooking levels. |  | Touch controls: Easy to use touch controls allow the appliance to be programmed at the touch of a button. |
|  | The capacity indicates the amount of usable space in the oven cavity in litres. | | |