





FMI125N

| | |
|--|----------------------|
| Usable volume | 25 l |
|  | |
| Product Family | Microwave |
| Category | Built-in |
| Installation | Fully Built-in |
| Power supply | Electric |
| Cooking Method | Microwave with grill |
| Control | Electronic |



Programs / Functions

| | |
|----------------------|---|
| No. of functions | 6 |
| Full grill |  |
| Pizza |  |
| Defrost by time |  |
| Defrost by weight |  |
| Microwave |  |
| Microwave + grill |  |
| Automatic programmes | 8 |

Controls

| | | | |
|--|---------------|---------|-------------------|
|  | | | |
| Display / Clock | 1 a LED | Opening | Electrical button |
| Type of control setting | Touch control | | |

Options

| | | | |
|--|-------------|-------------------------------|-----|
|  | | | |
| Timer | Electronic | End of cooking acoustic alarm | Yes |
| Time-setting options | End cooking | | |

| | |
|-------------------------------------|-----|
| Controls Lock / Child Safety | Yes |
|-------------------------------------|-----|

Technical Features

| | | | |
|----------------------------------|-----------------|---|----------------|
| Cavity material | Stainless steel | Door opening | Side-opening |
| No. of lights | 1 | Total no. of door glasses | 1 |
| Light type | Incandescent | Safety Thermostat | Yes |
| Turntable | Yes | Cooling system | Tangential |
| Turntable dimensions | 31.5 cm | Microwave screen protection | Yes |
| Light when door is opened | Yes | Microwave stops when door is opened | Yes |
| Grill type | Quartz | Usable cavity space dimensions (HxWxD) | 221x370x334 mm |
| Grill - power | 1000 W | Microwave effective power | 900 W |

Accessories Included







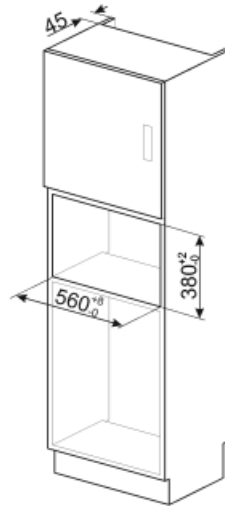
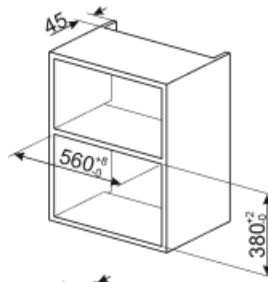
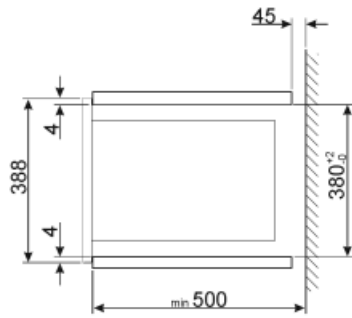
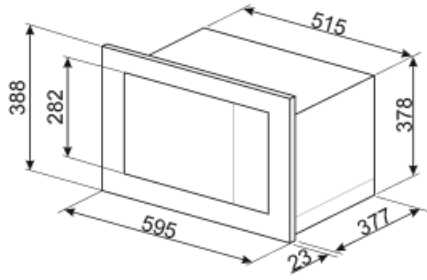



| | | | |
|-------------|---|--------------|-------------|
| Grid | 1 | Other | Suction cup |
|-------------|---|--------------|-------------|

Electrical Connection

| | | | |
|----------------------|-------------|----------------------------------|--------|
| Plug | Not present | Voltage (V) | 230 V |
| Nominal power | 1450 W | Frequency (Hz) | 50 Hz |
| Current | 6,3 A | Power supply cable length | 130 cm |



Symbols glossary (TT)

- | | | | |
|--|---|---|--|
|  | Child lock: some models are fitted with a device to lock the programme/cycle so it cannot be accidentally changed. |  | Microwave energy shortens cooking times dramatically and produces energy savings. |
|  | Defrost by time: Manual defrost function. At the end of the set duration, the function stops. |  | Defrost by weight: Automatic defrost function. You choose the type of food to defrost from the available categories (MEAT - FISH - BREAD - DESSERTS) After entering the weight of the food, the oven automatically defines the time required for proper defrosting. |
|  | Grill: Very intense heat coming only from above from a double heating element. The fan is not active. Provides excellent grilling and gratinating results. Used at the end of cooking, it gives a uniform browning to dishes. |  | Microwave: Penetrating straight into the food, microwaves cook very quickly and with considerable energy savings. Suitable for cooking without fat, they are also able to thaw and heat food without altering its original appearance and aroma. The microwave function can also be combined with conventional functions with all the resulting advantages. Ideal for all types of food. |
|  | Microwave + grill element: The use of the grill results in a perfect browning of the surface of the food. The action of microwaves allows instead of cooking in a short time the internal part of the food. |  | Pizza microwave: This function cooks pizza quicker thanks to the microwaves. To optimize the final result, use the function combined with the Chef plate |
|  | Touch controls: Easy to use touch controls allow the appliance to be programmed at the touch of a button. |  | The capacity indicates the amount of usable space in the oven cavity in litres. |