

# FMI125N



Product Family	Microwave
Category	Built-in
Installation type	Built-in
Installation	Fully Built-in
Power supply	Electric
Cooking Method	Microwave with grill
Control	Electronic



## Aesthetics

Aesthetic	Linea	Glass Type	Clear
Colour	Black	Serigraphy colour	Grey
Finishing	Glossy	Door	Full glass
Material	Glass	Logo	Silk screen

## Program / Functions



No. of functions	6	Defrost by weight	Yes
Full grill	Yes	Microwave	Yes
Pizza	Yes	Microwave + grill	Yes
Defrost by time	Yes	Automatic programmes	8

## Controls

Display / Clock	1 a LED	Opening	Electrical button
Type of control setting	Touch control		

## Options

Timer	Electronic	End of cooking acoustic alarm	Yes
Time-setting options	End cooking		

**Controls Lock / Child Safety** Yes

## Technical Features

<b>Cavity material</b>	Stainless steel	<b>Door opening</b>	Side-opening
<b>No. of lights</b>	1	<b>Total no. of door glasses</b>	1
<b>Light type</b>	Incandescent	<b>Safety Thermostat</b>	Yes
<b>Turntable</b>	Yes	<b>Cooling system</b>	Tangential
<b>Turntable dimensions</b>	31.5 cm	<b>Microwave screen protection</b>	Yes
<b>Light when door is opened</b>	Yes	<b>Microwave stops when door is opened</b>	Yes
<b>Grill type</b>	Quartz	<b>Usable cavity space dimensions (HxWxD)</b>	221x370x334 mm
<b>Grill - power</b>	1000 W	<b>Microwave effective power</b>	900 W

## Accessories included

<b>Grid</b>	1	<b>Other</b>	Suction cup
-------------	---	--------------	-------------

## Performance / Energy Label



<b>Usable volume</b>	25 l	<b>Gross volume</b>	26 l
----------------------	------	---------------------	------

## Electrical Connection

<b>Plug</b>	Not present	<b>Voltage (V)</b>	230 V
<b>Nominal power</b>	1450 W	<b>Frequency (Hz)</b>	50 Hz
<b>Current</b>	6.3 A	<b>Power supply cable length</b>	130 cm

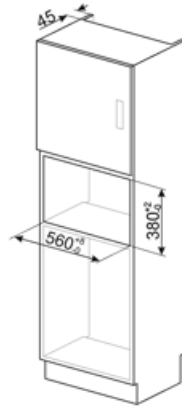
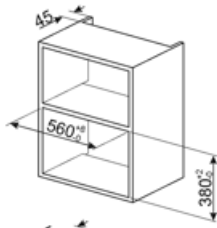

---

## Alternative products











---

**FMI125G**

**Colour: Neptune Grey**



## Symbols glossary

-  Child lock: some models are fitted with a device to lock the programme/cycle so it cannot be accidentally changed.
-  Defrost by time: Manual defrost function. At the end of the set duration, the function stops.
-  Grill: Very intense heat coming only from above from a double heating element. The fan is not active. Provides excellent grilling and gratinating results. Used at the end of cooking, it gives a uniform browning to dishes.
-  Microwave + grill element: The use of the grill results in a perfect browning of the surface of the food. The action of microwaves allows instead of cooking in a short time the internal part of the food.
-  Touch controls: Easy to use touch controls allow the appliance to be programmed at the touch of a button.
-  Microwave energy shortens cooking times dramatically and produces energy savings.
-  Defrost by weight: Automatic defrost function. You choose the type of food to defrost from the available categories (MEAT - FISH - BREAD - DESSERTS). After entering the weight of the food, the oven automatically defines the time required for proper defrosting.
-  Microwave: Penetrating straight into the food, microwaves cook very quickly and with considerable energy savings. Suitable for cooking without fat, they are also able to thaw and heat food without altering its original appearance and aroma. The microwave function can also be combined with conventional functions with all the resulting advantages. Ideal for all types of food.
-  Pizza microwave: This function cooks pizza quicker thanks to the microwaves. To optimize the final result, use the function combined with the Chef plate.
-  The capacity indicates the amount of usable space in the oven cavity in litres.