

FMI125N

Beschikbaar volume	25 l
	
Product familie	Microgolfoven
Categorie	Inbouw 38 cm
Installatie	Volledig integreerbaar
Voeding	Elektrisch
Bereidingswijze	Microgolf met grill
Bediening	Elektronisch

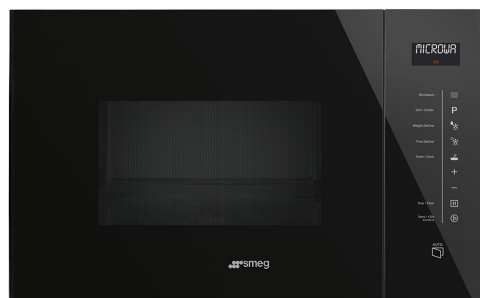

Bediening

			
Display / Klok	1 LED Display	Opening	Electrical button
Type bedieningsmechanisme	Touch bediening		

Opties

			
Timer	Elektronische timer	Geluidssignaal einde kooktijd	Ja
Opties tijdprogrammering	Eind	Kinderbeveiliging	Ja

Technische specificaties

Materiaal ovenruimte	Inox ovenruimte	Opening deur	Side-opening
Aantal lampen	1	Totaal aantal ruiten	1
Type lamp	Gloeilamp	Veiligheidsthermostaat	Ja
Draaiplateau	Ja	Koelsysteem	Mantelkoeling
Afmetingen draaiplateau	31.5 cm	Veiligheidsscherm microgolfdeur	Ja
Automatische inschakeling verlichting bij openen deur	Ja	Automatische uitschakeling microgolf bij openen deur	Ja
Type grill	Kwarts	Afmetingen bruikbare interne ovenruimte (hxbxd)	221x370x334 mm
Grill - vermogen	1000 W		

Effectief vermogen
microgolf

900 W

Meegeleverde accessoires

Ovenrooster

1

Overig

Suction cup

Elektrische aansluiting

Nominale
aansluitwaarde

1450 W

Frequentie (Hz)

50 Hz

Stroom

6,3 A

Lengte voedingskabel







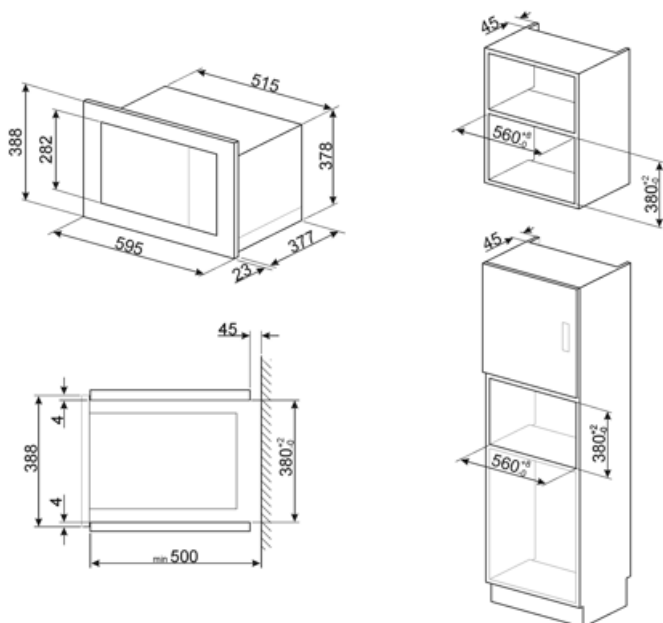



130 cm

Spanning (V)

230 V



Symbols glossary

-  Sommige modellen zijn voorzien van een functie om het programma/de cyclus te blokkeren zodat het niet per ongeluk kan aangepast worden.
-  Defrost by time: Manual defrost function. At the end of the set duration, the function stops.
-  Grill: Very intense heat coming only from above from a double heating element. The fan is not active. Provides excellent grilling and gratinating results. Used at the end of cooking, it gives a uniform browning to dishes.
-  Microwave + grill element: The use of the grill results in a perfect browning of the surface of the food. The action of microwaves allows instead of cooking in a short time the internal part of the food.
-  Bediening met touch knoppen: dankzij de gebruiksvriendelijke aanraakbediening kan het apparaat met één druk op de knop worden geprogrammeerd.
-  Microwave energy shortens cooking times dramatically and produces energy savings.
-  Defrost by weight: Automatic defrost function. You choose the type of food to defrost from the available categories (MEAT - FISH - BREAD - DESSERTS) After entering the weight of the food, the oven automatically defines the time required for proper defrosting.
-  Microwave: Penetrating straight into the food, microwaves cook very quickly and with considerable energy savings. Suitable for cooking without fat, they are also able to thaw and heat food without altering its original appearance and aroma. The microwave function can also be combined with conventional functions with all the resulting advantages. Ideal for all types of food.
-  Pizza microwave: This function cooks pizza quicker thanks to the microwaves. To optimize the final result, use the function combined with the Chef plate
-  The capacity indicates the amount of usable space in the oven cavity in litres.

Benefit (TT)

Electronic control

Timely temperature management and heat uniformity

Touch control

Easy operation of the display and cooking by touch

Automatic programmes

Preset programmes to simplify use and improve efficiency

Child control lock

Thanks to the child safety lock, the microwave provides peace of mind for parents while improving overall safety in the home environment

Pizza function

Preset mode for optimal baking or heating of pizza