

FMI25FO



Product Family	Microwave
Category	Built-in
Installation type	Built-in
Installation	Fully Built-in
Power supply	Electric
Cooking Method	Microwave with grill
Control	Electronic



Aesthetics

Aesthetic	Musa	Glass Type	Eclipse
Colour	Black	Serigraphy colour	Grey
Finishing	Glossy	Door	Full glass
Frame	Yes	Logo	Applied
Material	Glass		

Program / Functions



No. of functions	6	Microwave	Yes
Full grill	Yes	Microwave + grill	Yes
Defrost by time	Yes	Automatic programmes	8
Defrost by weight	Yes		

Controls

Display / Clock	1 a LED	Opening	Mechanical button
Type of control setting	Touch control		

Options

Timer	Electronic
-------	------------

Time-setting options	End cooking	Controls Lock / Child Safety	Yes
End of cooking acoustic alarm	Yes	Quick start option	Yes

Technical Features



Cavity material	Stainless steel	Door opening	Side-opening
No. of lights	1	Total no. of door glasses	1
Light type	Led	Safety Thermostat	Yes
Turntable	Yes	Cooling system	Tangential
Turntable dimensions	31,5 cm	Microwave screen protection	Yes
Light when door is opened	Yes	Microwave stops when door is opened	Yes
Grill type	Quartz	Usable cavity space dimensions (HxWxD)	206x368x328 mm
Grill - power	1000 W	Microwave effective power	900 W

Accessories included

Grid	1
------	---

Performance / Energy Label









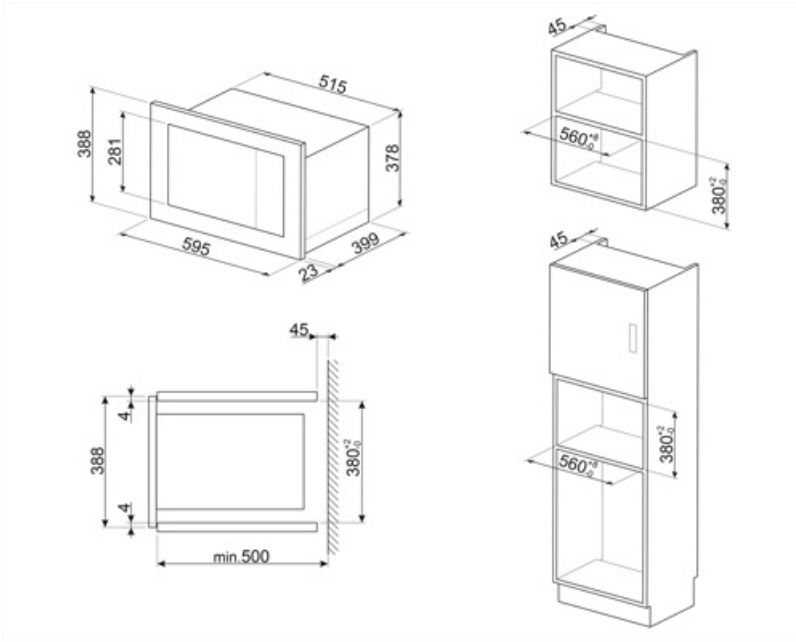



Usable volume	25 l	Gross volume	26 l
---------------	------	--------------	------

Electrical Connection

Plug	Not present	Voltage (V)	230 V
Nominal power	1450 W	Frequency (Hz)	50 Hz
Current	6,3 A	Power supply cable length	100 cm



Symbols glossary

-  Child lock: some models are fitted with a device to lock the programme/cycle so it cannot be accidentally changed.
-  Defrost by time: Manual defrost function. At the end of the set duration, the function stops.
-  Grill: Very intense heat coming only from above from a double heating element. The fan is not active. Provides excellent grilling and gratinating results. Used at the end of cooking, it gives a uniform browning to dishes.
-  Microwave + grill element: The use of the grill results in a perfect browning of the surface of the food. The action of microwaves allows instead of cooking in a short time the internal part of the food.
-  Touch controls: Easy to use touch controls allow the appliance to be programmed at the touch of a button.
-  Microwave energy shortens cooking times dramatically and produces energy savings.
-  Defrost by weight: Automatic defrost function. You choose the type of food to defrost from the available categories (MEAT - FISH - BREAD - DESSERTS). After entering the weight of the food, the oven automatically defines the time required for proper defrosting.
-  Microwave: Penetrating straight into the food, microwaves cook very quickly and with considerable energy savings. Suitable for cooking without fat, they are also able to thaw and heat food without altering its original appearance and aroma. The microwave function can also be combined with conventional functions with all the resulting advantages. Ideal for all types of food.
-  Side lights: Two opposing side lights increase visibility inside the oven.
-  The capacity indicates the amount of usable space in the oven cavity in litres.