

# FMI320X2

|  |                      |
|--|----------------------|
| Usable volume  | 20 l                 |
|  |                      |
| Product Family   | Microwave            |
| Category   | Built-in             |
| Installation   | With frame           |
| Tipo de energia  | Eléctrico            |
| Tipo de cozimento  | Microwave with grill |
| Control  | Electronic           |

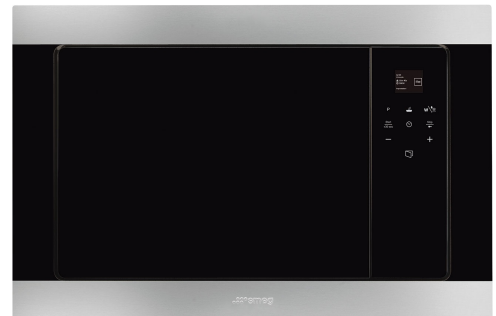



## Controls

|  |               |         |                   |
|--|---------------|---------|-------------------|
|  |               |         |                   |
| Display / Clock  | TFT           | Opening | Electrical button |
| Type of control setting  | Touch control |         |                   |

## Options

|  |             |                              |     |
|--|-------------|------------------------------|-----|
|  |             |                              |     |
| Timer  | Electronic  | Showroom demo option         | Yes |
| Time-setting options   | End cooking | Controls Lock / Child Safety | Yes |
| End of cooking acoustic alarm  | Yes         | Stop turntable option        | No  |
| Limited Power Consumption Mode   | Yes         | Quick start option           | Yes |

## Technical Features

|  |   |                             |              |
|--|---|-----------------------------|--------------|
|  |  |                             |              |
| Cavity material  | Stainless steel   | Tilting grill               | No           |
| No. of shelves/ levels   | 2   | Grill - power               | 1000 W       |
| Shelves type   | Rack  | Door opening                | Side-opening |
| No. of lights  | 1   | Full glass inner door       | No           |
| Light type   | Incandescent  | Total no. of door glasses   | 2            |
| Light user replaceable   | No  | Safety Thermostat           | No           |
| Light Power  | 20 W  | Cooling system              | Tangential   |
| Turntable  | Yes   | Microwave screen protection | Yes          |

|                           |         |  |                |
|---------------------------|---------|--|----------------|
| Ceramic base              | No      | Microwave stops when door is opened    | Yes            |
| Turntable dimensions      | 24.5 cm | Inverter                               | No             |
| Light when door is opened | Yes     | Usable cavity space dimensions (HxWxD) | 210x305x280 mm |
| Grill type                | Quartz  | Microwave effective power              | 850 W          |

## Accessories Included







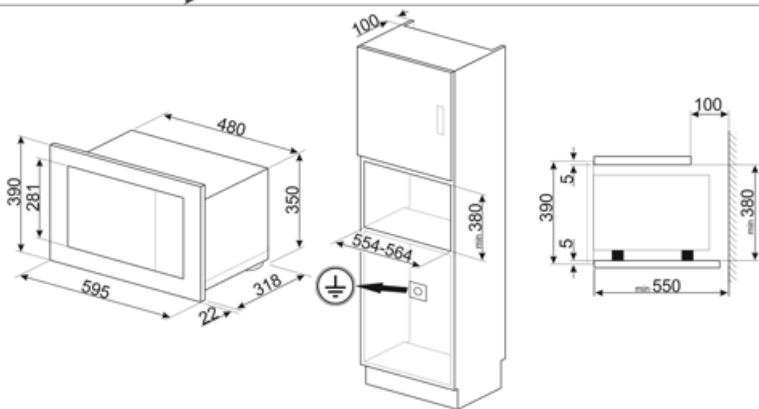
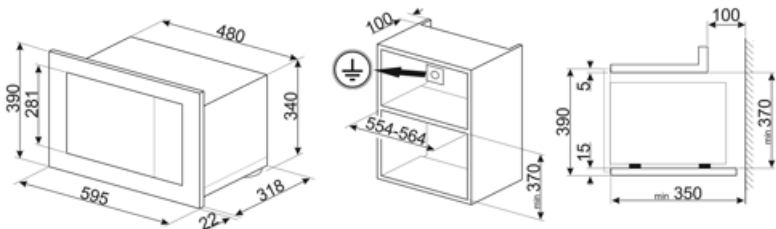





|       |    |       |     |
|-------|----|-------|-----|
| Grid  | 1  | Frame | Yes |
| Other | No |       |     |

## Electrical Connection

|               |        |                                    |        |
|---------------|--------|------------------------------------|--------|
| Plug          | No     | Voltage (V)                        | 230 V  |
| Nominal power | 1300 W | Frequency (Hz)                     | 50 Hz  |
| Current       | 5.2 A  | Comprimento do cabo de alimentação | 150 cm |



## Symbols glossary

- |  |  |   |  |
|--|--|---|--|
|    | Bloqueio para crianças: alguns modelos estão equipados com um dispositivo para bloquear o programa/ciclo para que não possa ser acidentalmente alterado.   |    | A energia de micro-ondas encurta drasticamente os tempos de cozimento e produz economia de energia.  |
|    | Descongela pelo tempo: com esta função, o tempo de descongelamento dos alimentos é determinado automaticamente.  |    | Descongela pelo peso: Com esta função, o tempo de descongelamento é determinado  |
|    | Portas de vidros duplos: Número de portas envidraçadas.  |    | Aço inoxidável à prova de dedadas: O aço inoxidável à prova de dedadas mantém o aço inoxidável com um aspeto novo.   |
|    | Elemento de grelha O uso de grelha dá excelentes resultados ao cozinhar carne de porções médias e pequenas, especialmente quando combinada com uma rotisseria (sempre que possível). Também é ideal para cozinhar salsichas e bacon. |    | Micro-ondas Penetrando diretamente na comida, micro-ondas cozinham muito rapidamente e com considerável economia de energia. Adequados para cozinhar sem gordura, eles também são capazes de descongelar e aquecer alimentos sem alterar a sua aparência original e aroma. A função de micro-ondas também pode ser combinada com funções convencionais com todas as vantagens resultantes. Ideal para todos os tipos de alimentos. |
|  | Micro-ondas + elemento de grelha: O uso da grelha resulta em um perfeito escurecimento da superfície dos alimentos. A ação de micro-ondas permite em vez de cozinhar em pouco tempo a parte interna do alimento.                     |  | O compartimento do forno tem 2 níveis de cozimento diferentes.   |
|  | Controles táteis: O controles táteis, fáceis de usar, permitem que o aparelho seja programado com o toque de um botão.   |  | A capacidade indica a quantidade de espaço útil no compartimento do forno em litros.   |

---

## Benefit (TT)

---

### **Electronic control**

Timely temperature management and heat uniformity

### **Touch control**

Easy operation of the display and cooking by touch

### **Automatic programmes**

Preset programmes to simplify use and improve efficiency

### **Child control lock**

Thanks to the child safety lock, the microwave provides peace of mind for parents while improving overall safety in the home environment

### **Quick start**

One-touch cooking and heating start-up with the Quick Start option for a simple and intuitive user experience