







FMI325X

Usable volume	25 l
	
Product Family	Microwave
Category	Built-in
Installation	Fully Built-in
Power supply	Electric
Cooking Method	Microwave with grill
Control	Electromechanical



Programs / Functions

No. of functions	6
Full grill	
Pizza	
Defrost by time	
Defrost by weight	
Microwave	
Microwave + grill	
Automatic programmes	8

Controls

			
Display / Clock	1 a LED	Opening	Electrical button
Type of control setting	Touch control		

Options

			
Timer	Electronic	Controls Lock / Child Safety	Yes
Time-setting options	End cooking	Quick start option	Yes

End of cooking acoustic alarm Yes

Technical Features



Cavity material	Stainless steel	Grill - power	1000 W
No. of shelves/ levels	2	Door opening	Side-opening
Shelves type	Rack	Total no. of door glasses	1
No. of lights	1	Safety Thermostat	Yes
Light type	Led	Cooling system	Tangential
Turntable	Yes	Microwave screen protection	Yes
Turntable dimensions	31.5 cm	Microwave stops when door is opened	Yes
Light when door is opened	Yes	Usable cavity space dimensions (HxWxD)	206x368x328 mm
Grill type	Quartz	Microwave effective power	900 W

Accessories Included







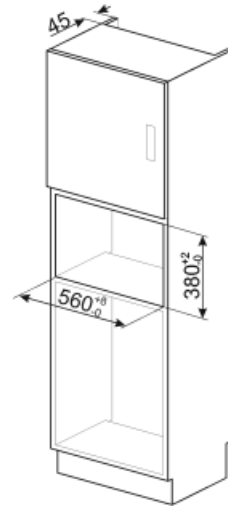
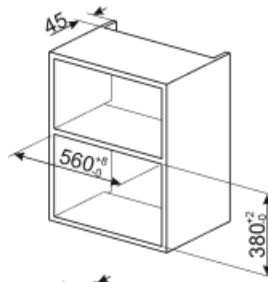
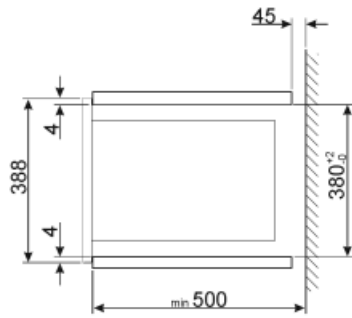
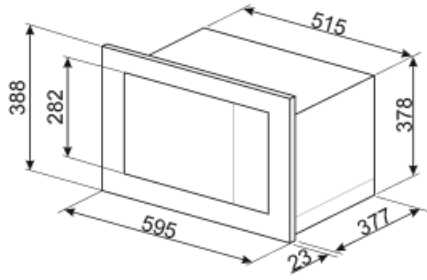





Grid	1	Frame	Yes
-------------	---	--------------	-----

Electrical Connection

Nominal power	1450 W	Frequency (Hz)	50 Hz
Current	6,3 A	Power supply cable length	150 cm
Voltage (V)	230 V		



Symbols glossary (TT)

	Child lock: some models are fitted with a device to lock the programme/cycle so it cannot be accidentally changed.		Microwave energy shortens cooking times dramatically and produces energy savings.
	Defrost by time: with this function the time of thawing of foods are determined automatically.		Defrost by weight: With this function the defrosting time is determined
	Grill element: Using of grill gives excellent results when cooking meat of medium and small portions, especially when combined with a rotisserie (where possible). Also ideal for cooking sausages and bacon.		Microwave: Penetrating straight into the food, microwaves cook very quickly and with considerable energy savings. Suitable for cooking without fat, they are also able to thaw and heat food without altering its original appearance and aroma. The microwave function can also be combined with conventional functions with all the resulting advantages. Ideal for all types of food.
	Microwave + grill element: The use of the grill results in a perfect browning of the surface of the food. The action of microwaves allows instead of cooking in a short time the internal part of the food.		Pizza microwave: This function cooks pizza quicker thanks to the microwaves. To optimize the final result, use the function combined with the Chef plate
	Side lights: Two opposing side lights increase visibility inside the oven.		The oven cavity has 2 different cooking levels.
	Touch controls: Easy to use touch controls allow the appliance to be programmed at the touch of a button.		The capacity indicates the amount of usable space in the oven cavity in litres.