

FMI325X

Usable volume

25 l



Product Family

Microwave

Category

Built-in

Installation

Fully Built-in

Power supply

Electric

Cooking Method

Microwave with grill

Control

Electromechanical



Controls



Display / Clock

1 a LED

Opening

Electrical button

Type of control setting

Touch control

Options



Timer

Electronic

Controls Lock / Child

Yes

Time-setting options

End cooking

Safety

End of cooking acoustic alarm

Yes

Quick start option

Yes

Technical Features



Cavity material

Stainless steel

Grill - power

1000 W

No. of shelves/ levels

2

Door opening

Side-opening

Shelves type

Rack

Total no. of door glasses

1

No. of lights

1

Safety Thermostat

Yes

Light type

Led

Cooling system

Tangential

Turntable

Yes

Microwave screen protection

Yes

Turntable dimensions

31.5 cm

Light when door is opened

Yes

Microwave stops when door is opened

Yes

Grill type

Quartz

Usable cavity space dimensions (HxWxD)	206x368x328 mm
Microwave effective power	900 W

Accessories Included







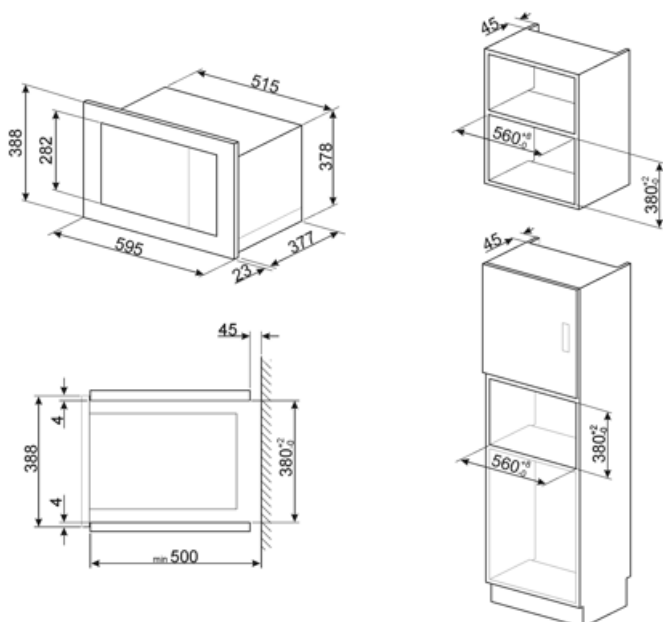





Grid	1	Frame	Yes
------	---	-------	-----

Electrical Connection

Plug	Not present	Voltage (V)	230 V
Nominal power	1450 W	Frequency (Hz)	50 Hz
Current	6,3 A	Power supply cable length	150 cm



Symbols glossary (TT)

	Child lock: some models are fitted with a device to lock the programme/cycle so it cannot be accidentally changed.		Microwave energy shortens cooking times dramatically and produces energy savings.
	Defrost by time: Manual defrost function. At the end of the set duration, the function stops.		Defrost by weight: Automatic defrost function. You choose the type of food to defrost from the available categories (MEAT - FISH - BREAD - DESSERTS) After entering the weight of the food, the oven automatically defines the time required for proper defrosting.
	Grill: Very intense heat coming only from above from a double heating element. The fan is not active. Provides excellent grilling and gratinating results. Used at the end of cooking, it gives a uniform browning to dishes.		Microwave: Penetrating straight into the food, microwaves cook very quickly and with considerable energy savings. Suitable for cooking without fat, they are also able to thaw and heat food without altering its original appearance and aroma. The microwave function can also be combined with conventional functions with all the resulting advantages. Ideal for all types of food.
	Microwave + grill element: The use of the grill results in a perfect browning of the surface of the food. The action of microwaves allows instead of cooking in a short time the internal part of the food.		Pizza microwave: This function cooks pizza quicker thanks to the microwaves. To optimize the final result, use the function combined with the Chef plate
	Side lights: Two opposing side lights increase visibility inside the oven.		The oven cavity has 2 different cooking levels.
	Touch controls: Easy to use touch controls allow the appliance to be programmed at the touch of a button.		The capacity indicates the amount of usable space in the oven cavity in litres.