

# FMI325X



<b>Product Family</b>	Microwave
<b>Category</b>	Built-in
<b>Installation type</b>	Built-in
<b>Installation</b>	Fully Built-in
<b>Power supply</b>	Electric
<b>Cooking Method</b>	Microwave with grill
<b>Control</b>	Electromechanical



## Aesthetics

<b>Aesthetic</b>	Classica	<b>Type of steel</b>	Brushed
<b>Colour</b>	Stainless steel	<b>Glass Type</b>	Eclipse
<b>Finishing</b>	Fingerproof	<b>Serigraphy colour</b>	White
<b>Frame</b>	Yes	<b>Door</b>	Full glass
<b>Material</b>	Stainless steel	<b>Logo</b>	Embossed

## Program / Functions

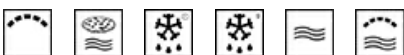

<b>No. of functions</b>	6	<b>Defrost by weight</b>	Yes
<b>Full grill</b>	Yes	<b>Microwave</b>	Yes
<b>Pizza</b>	Yes	<b>Microwave + grill</b>	Yes
<b>Defrost by time</b>	Yes	<b>Automatic programmes</b>	8

## Controls



<b>Display / Clock</b>	1 a LED	<b>Opening</b>	Electrical button
<b>Type of control setting</b>	Touch control		

## Options



<b>Timer</b>	Electronic
--------------	------------

Time-setting options	End cooking	Controls Lock / Child Safety	Yes
End of cooking acoustic alarm	Yes	Quick start option	Yes

## Technical Features



Cavity material	Stainless steel	Grill - power	1000 W
No. of shelves/ levels	2	Door opening	Side-opening
Shelves type	Rack	Total no. of door glasses	1
No. of lights	1	Safety Thermostat	Yes
Light type	Led	Cooling system	Tangential
Turntable	Yes	Microwave screen protection	Yes
Turntable dimensions	31,5 cm	Microwave stops when door is opened	Yes
Light when door is opened	Yes	Usable cavity space dimensions (HxWxD)	206x368x328 mm
Grill type	Quartz	Microwave effective power	900 W

## Accessories included

Grid	1	Frame	Yes
------	---	-------	-----

## Performance / Energy Label















Usable volume	25 l	Gross volume	26 l
---------------	------	--------------	------

## Electrical Connection

Plug	Not present	Voltage (V)	230 V
Nominal power	1450 W	Frequency (Hz)	50 Hz
Current	6,3 A	Power supply cable length	150 cm



## Symbols glossary

-  Child lock: some models are fitted with a device to lock the programme/cycle so it cannot be accidentally changed.
-  Defrost by time: Manual defrost function. At the end of the set duration, the function stops.
-  Fingerprint proof stainless steel: Fingerprint proof stainless steel keeps stainless steel looking as good as new.
-  Microwave: Penetrating straight into the food, microwaves cook very quickly and with considerable energy savings. Suitable for cooking without fat, they are also able to thaw and heat food without altering its original appearance and aroma. The microwave function can also be combined with conventional functions with all the resulting advantages. Ideal for all types of food.
-  Pizza microwave: This function cooks pizza quicker thanks to the microwaves. To optimize the final result, use the function combined with the Chef plate.
-  The oven cavity has 2 different cooking levels.
-  The capacity indicates the amount of usable space in the oven cavity in litres.
-  Microwave energy shortens cooking times dramatically and produces energy savings.
-  Defrost by weight: Automatic defrost function. You choose the type of food to defrost from the available categories (MEAT - FISH - BREAD - DESSERTS). After entering the weight of the food, the oven automatically defines the time required for proper defrosting.
-  Grill: Very intense heat coming only from above from a double heating element. The fan is not active. Provides excellent grilling and gratinating results. Used at the end of cooking, it gives a uniform browning to dishes.
-  Microwave + grill element: The use of the grill results in a perfect browning of the surface of the food. The action of microwaves allows instead of cooking in a short time the internal part of the food.
-  Side lights: Two opposing side lights increase visibility inside the oven.
-  Touch controls: Easy to use touch controls allow the appliance to be programmed at the touch of a button.