

FMI325XUK



Product Family	Microwave
Category	Built-in
Installation type	Built-in
Installation	Fully Built-in
Power supply	Electric
Cooking Method	Microwave with grill
Control	Electromechanical



Aesthetics

Aesthetics	Classic	Type of steel	Brushed
Colour	Stainless steel	Glass Type	Eclipse
Finishing	Fingerproof	Serigraphy colour	White
Frame	Yes	Door	Full glass
Material	Stainless steel	Logo	Embossed

Program / Functions



No. of functions	6	Defrost by weight	Yes
Full grill	Yes	Microwave	Yes
Pizza	Yes	Microwave + grill	Yes
Defrost by time	Yes	Automatic programmes	8

Controls



Display / Clock	1 a LED	Opening	Electrical button
Type of control setting	Touch control		

Options



Timer	Electronic
-------	------------

Time-setting options	End cooking	Controls Lock / Child Safety	Yes
End of cooking acoustic alarm	Yes	Quick start option	Yes

Technical Features



Cavity material	Stainless steel	Grill - power	1000 W
Shelf positions	2	Door opening	Side-opening
Shelves type	Rack	Total no. of door glasses	1
No. of lights	1	Safety Thermostat	Yes
Light type	LED	Cooling system	Tangential
Turntable	Yes	Microwave screen protection	Yes
Turntable dimensions	31,5 cm	Microwave stops when door is opened	Yes
Light when door is opened	Yes	Usable cavity space dimensions (HxWxD)	206x368x328 mm
Grill type	Quartz	Microwave effective power	900 W

Accessories Included

Grid	1	Frame	Yes
------	---	-------	-----

Performance / Energy Label









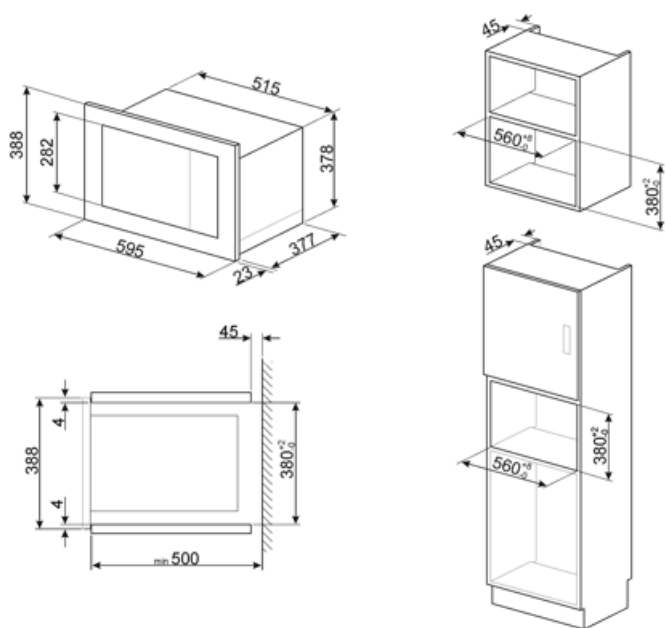





Usable volume	25 l	Gross volume	26 l
---------------	------	--------------	------

Electrical Connection

Plug	No	Voltage (V)	230 V
Nominal power (W)	1450 W	Frequency (Hz)	50 Hz
Current	6,3 A	Power supply cable length	150 cm



Symbols glossary

-  Child lock: some models are fitted with a device to lock the programme/cycle so it cannot be accidentally changed.
-  Defrost by time: with this function the time of thawing of foods are determined automatically.
-  Fingerprint proof stainless steel: Fingerprint proof stainless steel keeps stainless steel looking as good as new.
-  Microwave: Penetrating straight into the food, microwaves cook very quickly and with considerable energy savings. Suitable for cooking without fat, they are also able to thaw and heat food without altering its original appearance and aroma. The microwave function can also be combined with conventional functions with all the resulting advantages. Ideal for all types of food.
-  Pizza microwave: This function cooks pizza quicker thanks to the microwaves. To optimize the final result, use the function combined with the Chef plate
-  The oven cavity has 2 different cooking levels.
-  The capacity indicates the amount of usable space in the oven cavity in litres.
-  Microwave energy shortens cooking times dramatically and produces energy savings.
-  Defrost by weight: With this function the defrosting time is determined
-  Grill element: Using of grill gives excellent results when cooking meat of medium and small portions, especially when combined with a rotisserie (where possible). Also ideal for cooking sausages and bacon.
-  Microwave + grill element: The use of the grill results in a perfect browning of the surface of the food. The action of microwaves allows instead of cooking in a short time the internal part of the food.
-  Side lights: Two opposing side lights increase visibility inside the oven.
-  Touch controls: Easy to use touch controls allow the appliance to be programmed at the touch of a button.