

FMI425X

Usable volume	25 l
	
Product Family	Microwave
Category	Built-in
Installation	Fully Built-in
Power supply	Electric
Cooking Method	Microwave with grill
Control	Electromechanical



Programme / Functions

No. of functions	5
Full grill	
Defrost by time	
Defrost by weight	
Microwave	
Microwave + grill	
Automatic programmes	8
Other Microwave functions	Multi-session cooking

Controls

Display / Clock	1 a LED	Control knobs	Push-push
Type of control setting	Control knobs / buttons	Controls colour	Steel effect
Opening	Mechanical button	Buttons Colour	Steel effect
No. of controls	1		

Options

			
Timer	Electronic	Controls Lock / Child Safety	Yes
Time-setting options	End cooking	Quick start option	Yes

End of cooking acoustic alarm Yes

Technical Features



Cavity material	Stainless steel	Grill - power	1000 W
No. of shelves/ levels	2	Door opening	Side-opening
Shelves type	Rack	Total no. of door glasses	1
No. of lights	1	Safety Thermostat	Yes
Light type	Led	Cooling system	Tangential
Turntable	Yes	Microwave screen protection	Yes
Turntable dimensions	31.5 cm	Microwave stops when door is opened	Yes
Light when door is opened	Yes	Usable cavity space dimensions (HxWxD)	206x368x328 mm
Grill type	Quartz	Microwave effective power	900 W

Accessories Included







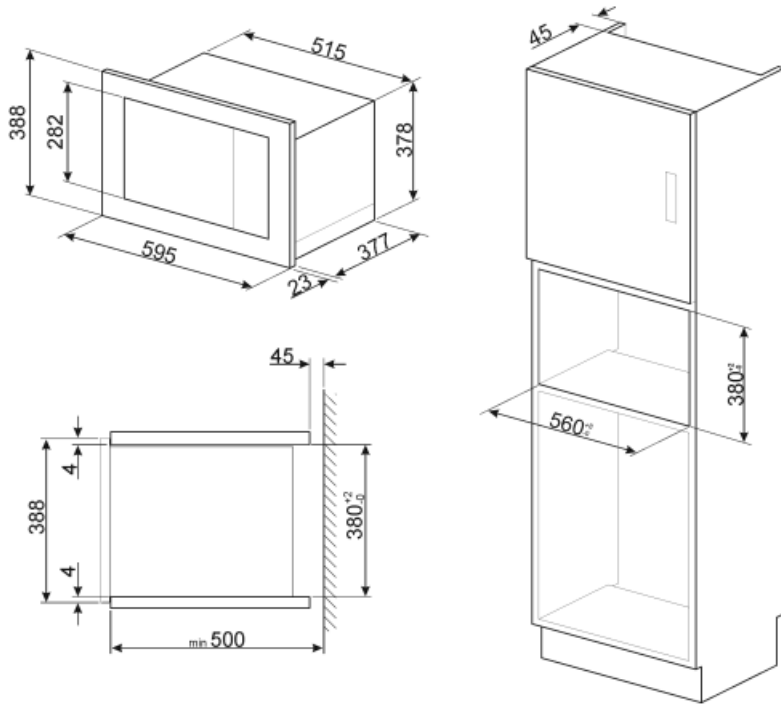



Grid 1

Electrical Connection

Plug	Not present	Voltage (V)	230 V
Nominal power	1450 W	Frequency (Hz)	50 Hz
Current	6.3 A	Power supply cable length	150 cm



Symbols glossary (TT)

	Child lock: some models are fitted with a device to lock the programme/cycle so it cannot be accidentally changed.		Microwave energy shortens cooking times dramatically and produces energy savings.
	Defrost by time: Manual defrost function. At the end of the set duration, the function stops.		Defrost by weight: Automatic defrost function. You choose the type of food to defrost from the available categories (MEAT - FISH - BREAD - DESSERTS) After entering the weight of the food, the oven automatically defines the time required for proper defrosting.
	Grill: Very intense heat coming only from above from a double heating element. The fan is not active. Provides excellent grilling and gratinating results. Used at the end of cooking, it gives a uniform browning to dishes.		Microwave: Penetrating straight into the food, microwaves cook very quickly and with considerable energy savings. Suitable for cooking without fat, they are also able to thaw and heat food without altering its original appearance and aroma. The microwave function can also be combined with conventional functions with all the resulting advantages. Ideal for all types of food.
	Microwave + grill element: The use of the grill results in a perfect browning of the surface of the food. The action of microwaves allows instead of cooking in a short time the internal part of the food.		Side lights: Two opposing side lights increase visibility inside the oven.
	The oven cavity has 2 different cooking levels.		The capacity indicates the amount of usable space in the oven cavity in litres.