

# FMI425X



<b>Product familie</b>	Microgolfoven
<b>Categorie</b>	Inbouw 38 cm
<b>Installation type</b>	Inbouw 38 cm
<b>Installatie</b>	Volledig integreerbaar
<b>Voeding</b>	Elektrisch
<b>Bereidingswijze</b>	Microgolf met grill
<b>Bediening</b>	Elektro-mechanisch



## Design

<b>Design</b>	Elementi	<b>Type roestvrijstaal</b>	Geborsteld inox
<b>Kleur</b>	Inox	<b>Type glas</b>	Eclipse zwart glas
<b>Afwerking</b>	Fingerproof	<b>Kleur serigrafie</b>	Zwart
<b>Kader</b>	Ja	<b>Deur</b>	Met paneel
<b>Materiaal</b>	Inox	<b>Logo</b>	In reliëf

## Program / Functions



<b>Aantal functies</b>	5	<b>Microgolfoven</b>	Ja
<b>Grote vlakgrill</b>	Ja	<b>Microgolfoven + grill</b>	Ja
<b>Ontdooien op tijd</b>	Ja	<b>Automatische programma's</b>	8
<b>Ontdooien op gewicht</b>	Ja	<b>Overige functies microgolf</b>	Multi-session cooking

## Bediening

<b>Display / Klok</b>	1 LED Display	<b>Bedieningsknoppen</b>	Push-push
<b>Type bedieningsmechanisme</b>	Bedieningsknoppen/ -toetsen	<b>Kleur knoppen</b>	Inox look
<b>Opening</b>	Mechanical button	<b>Kleur toetsen</b>	Inox look
<b>Aantal bedieningsknoppen</b>	1		

## Opties



<b>Timer</b>	Elektronische timer	<b>Kinderbeveiliging</b>	Ja
<b>Opties tijdprogrammering</b>	Eind	<b>Quick Start optie</b>	Ja
<b>Geluidssignaal einde kooktijd</b>	Ja		

## Technische specificaties



<b>Materiaal ovenruimte</b>	Inox ovenruimte	<b>Grill - vermogen</b>	1000 W
<b>Aantal kookniveaus</b>	2	<b>Opening deur</b>	Side-opening
<b>Type ovenrekken</b>	Verhoogd rooster	<b>Totaal aantal ruiten</b>	1
<b>Aantal lampen</b>	1	<b>Veiligheidsthermostaat</b>	Ja
<b>Type lamp</b>	LED	<b>Koelsysteem</b>	Mantelkoeling
<b>Draaiplateau</b>	Ja	<b>Veiligheidsscherm microgolfdeur</b>	Ja
<b>Afmetingen draaiplateau</b>	31,5 cm	<b>Automatische uitschakeling microgolf bij openen deur</b>	Ja
<b>Automatische inschakeling verlichting bij openen deur</b>	Ja	<b>Afmetingen bruikbare interne ovenruimte (hxbxd)</b>	206x368x328 mm
<b>Type grill</b>	Kwarts	<b>Effectief vermogen microgolf</b>	900 W

## Meegeleverde accessoires

<b>Ovenrooster</b>	1
--------------------	---

## Prestaties / energielabel









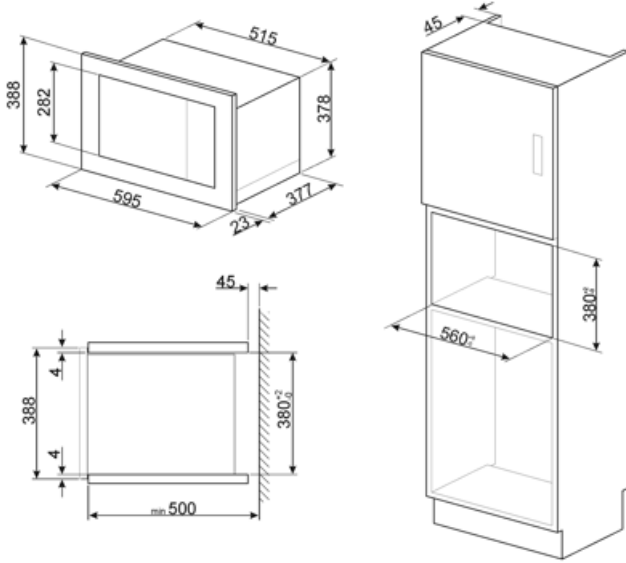



<b>Beschikbaar volume</b>	25 l	<b>Bruto inhoud</b>	26 l
---------------------------	------	---------------------	------

## Elektrische aansluiting

<b>Stekker</b>	Nee	<b>Spanning (V)</b>	230 V
<b>Nominale aansluitwaarde</b>	1450 W	<b>Frequentie (Hz)</b>	50 Hz
<b>Stroom</b>	6,3 A	<b>Lengte voedingskabel</b>	150 cm



## Symbols glossary

-  Sommige modellen zijn voorzien van een functie om het programma/de cyclus te blokkeren zodat het niet per ongeluk kan aangepast worden.
-  Defrost by time: Manual defrost function. At the end of the set duration, the function stops.
-  Fingerprint proof stainless steel: Fingerprint proof stainless steel keeps stainless steel looking as good as new.
-  Microwave: Penetrating straight into the food, microwaves cook very quickly and with considerable energy savings. Suitable for cooking without fat, they are also able to thaw and heat food without altering its original appearance and aroma. The microwave function can also be combined with conventional functions with all the resulting advantages. Ideal for all types of food.
-  Side lights: Two opposing side lights increase visibility inside the oven.
-  The capacity indicates the amount of usable space in the oven cavity in litres.
-  Microwave energy shortens cooking times dramatically and produces energy savings.
-  Defrost by weight: Automatic defrost function. You choose the type of food to defrost from the available categories (MEAT - FISH - BREAD - DESSERTS). After entering the weight of the food, the oven automatically defines the time required for proper defrosting.
-  Grill: Very intense heat coming only from above from a double heating element. The fan is not active. Provides excellent grilling and gratinating results. Used at the end of cooking, it gives a uniform browning to dishes.
-  Microwave + grill element: The use of the grill results in a perfect browning of the surface of the food. The action of microwaves allows instead of cooking in a short time the internal part of the food.
-  The oven cavity has 2 different cooking levels.