

FMIA120B1

Bruikbare inhoud	20 l
	
Familie	Magnetron
Categorie	Inbouw
Installatie	Met frame
Voeding	Elektrisch
Bereidingswijze	Magnetron met grill
Bediening	Elektronisch



Bediening

			
Display / Klok	TFT	Opening	Mechanical button
Type bediening	Touch control		

Opties

			
Timer	Elektronisch	Showroom demo optie	Ja
Opties	Eind	Kinderbeveiliging	Ja
tijdprogrammering		Quick Start optie	Ja
Akoestisch signaal	Ja		
einde kooktijd			
ECO-Logic optie	Ja		

Technische specificaties

			
Materiaal ovenruimte	Roestvrij staal	Grill - vermogen	1000 W
Aantal lampen	1	Deur openen	Side-opening
Soort verlichting	Gloeilamp	Totaal aantal ruiten	2
Vermogen lamp	20 W	Koelsysteem	Mantelkoeling
Draaiplateau	Ja	Veiligheidsscherm	Ja
Afmetingen	24.5 cm	magnetrondeur	
draaiplateau		Automatische	Ja
		uitschakeling magnetron	
		bij openen deur	

Automatische inschakeling verlichting bij openen deur	Ja	Afmetingen bruikbare interne ovenruimte (hxbxd)	210x305x305 mm
Type grill	Kwarts	Effectief magnetronvermogen	800 W

Meegeleverde accessoires







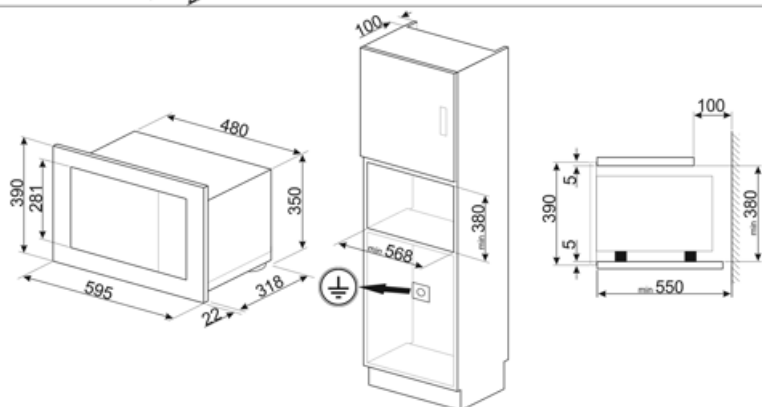
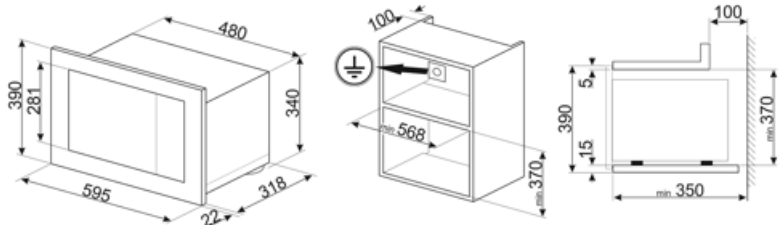



Ovenrooster	1	Kader	Ja
-------------	---	-------	----

Elektrische aansluiting

Stekker	(I) Australia	Spanning (V)	230 V
Aansluitwaarde	1200 W	Frequentie (Hz)	50 Hz
Stroom	5,2 A	Lengte voedingskabel	150 cm



Symbols glossary

- | | | | |
|--|--|---|---|
|  | Kinderslot: sommige modellen zijn voorzien van een apparaat om het programma / de cyclus te vergrendelen zodat het niet kan per ongeluk veranderd |  | Microwave energy shortens cooking times dramatically and produces energy savings. |
|  | Ontdooien op tijd: met deze functie wordt automatisch het tijdstip van ontdooien van voedsel bepaald |  | Ontdooien op gewicht: Met deze functie wordt de ontdooitijd bepaald |
|  | Dubbele beglazing: aantal glazen deuren. |  | De warmte wordt geproduceerd door het grill- en bovenelement. Verhitting over het volledige oppervlak. De thermostaat wordt, afhankelijk van het gerecht, in de regel op de maximale stand gezet. Bij een korte baktijd kan de oven deur gesloten blijven; bij langere baktijd blijft deze gedeeltelijk geopend. Voor vleesgerechten (klein- en middelgroot), vleespennen, vis, groenten, gratineren etc. |
|  | Microwave: Penetrating straight into the food, microwaves cook very quickly and with considerable energy savings. Suitable for cooking without fat, they are also able to thaw and heat food without altering its original appearance and aroma. The microwave function can also be combined with conventional functions with all the resulting advantages. Ideal for all types of food. |  | Microwave + grill element: The use of the grill results in a perfect browning of the surface of the food. The action of microwaves allows instead of cooking in a short time the internal part of the food. |
|  | Touch control: dankzij de gebruiksvriendelijke Touch control kan het apparaat met één druk op de knop worden geprogrammeerd. |  | The capacity indicates the amount of usable space in the oven cavity in litres. |

Benefit (TT)

Electronic control

Timely temperature management and heat uniformity

Touch control

Easy operation of the display and cooking by touch

Automatic programmes

Preset programmes to simplify use and improve efficiency

Child control lock

Thanks to the child safety lock, the microwave provides peace of mind for parents while improving overall safety in the home environment

Quick start

One-touch cooking and heating start-up with the Quick Start option for a simple and intuitive user experience