

# FMIA320X2

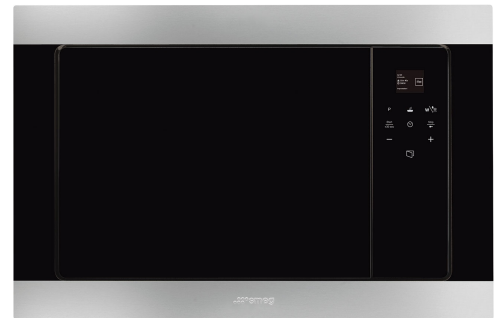

|                          |                      |
|--------------------------|----------------------|
| <b>Product Family</b>    | Microwave            |
| <b>Category</b>          | Built-in             |
| <b>Installation type</b> | Built-in             |
| <b>Installation</b>      | With frame           |
| <b>Power supply</b>      | Electric             |
| <b>Cooking Method</b>    | Microwave with grill |
| <b>Control</b>           | Electronic           |



## Aesthetics

|                  |                 |                          |            |
|------------------|-----------------|--------------------------|------------|
| <b>Aesthetic</b> | Classic         | <b>Glass Type</b>        | Eclipse    |
| <b>Colour</b>    | Stainless steel | <b>Serigraphy colour</b> | Grey       |
| <b>Finishing</b> | Fingerproof     | <b>Door</b>              | Full glass |
| <b>Material</b>  | Glass           | <b>Logo</b>              | Embossed   |

## Program / Functions



|                          |     |                                  |        |
|--------------------------|-----|----------------------------------|--------|
| <b>No. of functions</b>  | 5   | <b>Microwave</b>                 | Yes    |
| <b>Full grill</b>        | Yes | <b>Microwave + grill</b>         | Yes    |
| <b>Defrost by time</b>   | Yes | <b>Automatic programmes</b>      | 3      |
| <b>Defrost by weight</b> | Yes | <b>Other Microwave functions</b> | Memory |

## Controls

|                                                                                    |                                |               |                |                   |
|------------------------------------------------------------------------------------|--------------------------------|---------------|----------------|-------------------|
|  | <b>Display / Clock</b>         | TFT           | <b>Opening</b> | Electrical button |
|                                                                                    | <b>Type of control setting</b> | Touch control |                |                   |

## Options

|                                                                                    |              |            |                             |     |
|------------------------------------------------------------------------------------|--------------|------------|-----------------------------|-----|
|  | <b>Timer</b> | Electronic | <b>Showroom demo option</b> | Yes |
|------------------------------------------------------------------------------------|--------------|------------|-----------------------------|-----|

|                                |             |                              |     |
|--------------------------------|-------------|------------------------------|-----|
| Time-setting options           | End cooking | Controls Lock / Child Safety | Yes |
| End of cooking acoustic alarm  | Yes         | Quick start option           | Yes |
| Limited Power Consumption Mode | Yes         |                              |     |

## Technical Features



|                           |                 |                                        |                |
|---------------------------|-----------------|----------------------------------------|----------------|
| Cavity material           | Stainless steel | Grill - power                          | 1000 W         |
| No. of lights             | 1               | Door opening                           | Side-opening   |
| Light type                | Incandescent    | Total no. of door glasses              | 2              |
| Light Power               | 20 W            | Cooling system                         | Tangential     |
| Turntable                 | Yes             | Microwave screen protection            | Yes            |
| Turntable dimensions      | 25 cm           | Microwave stops when door is opened    | Yes            |
| Light when door is opened | Yes             | Usable cavity space dimensions (HxWxD) | 210x305x280 mm |
| Grill type                | Quartz          | Microwave effective power              | 800 W          |

## Accessories Included

|      |   |       |     |
|------|---|-------|-----|
| Grid | 1 | Frame | Yes |
|------|---|-------|-----|

## Performance / Energy Label









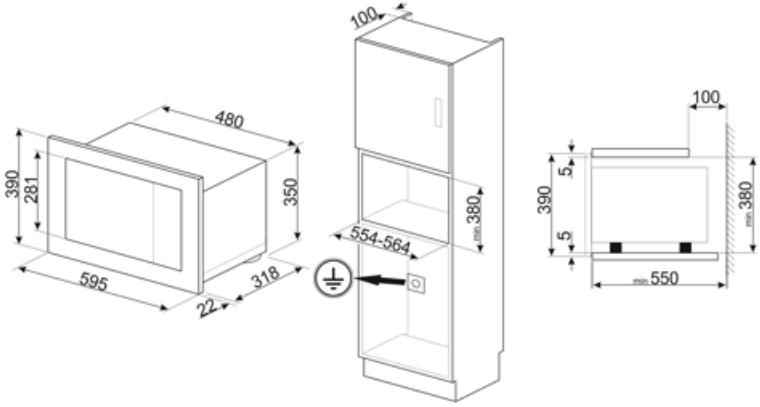



|               |      |              |      |
|---------------|------|--------------|------|
| Usable volume | 20 l | Gross volume | 21 l |
|---------------|------|--------------|------|

## Electrical Connection

|               |               |                           |        |
|---------------|---------------|---------------------------|--------|
| Plug          | (I) Australia | Voltage (V)               | 230 V  |
| Nominal power | 1300 W        | Frequency (Hz)            | 50 Hz  |
| Current       | 5,2 A         | Power supply cable length | 150 cm |



## Symbols glossary

- |                                                                                    |                                                                                                                                                                                                                                                                                                                                                                                          |                                                                                     |                                                                                                                                                                                                               |
|------------------------------------------------------------------------------------|------------------------------------------------------------------------------------------------------------------------------------------------------------------------------------------------------------------------------------------------------------------------------------------------------------------------------------------------------------------------------------------|-------------------------------------------------------------------------------------|---------------------------------------------------------------------------------------------------------------------------------------------------------------------------------------------------------------|
|    | Child lock: some models are fitted with a device to lock the programme/cycle so it cannot be accidentally changed.                                                                                                                                                                                                                                                                       |    | Microwave energy shortens cooking times dramatically and produces energy savings.                                                                                                                             |
|    | Defrost by time: with this function the time of thawing of foods are determined automatically.                                                                                                                                                                                                                                                                                           |    | Defrost by weight: With this function the defrosting time is determined                                                                                                                                       |
|    | Double glazed doors: Number of glazed doors.                                                                                                                                                                                                                                                                                                                                             |    | Grill element: Using of grill gives excellent results when cooking meat of medium and small portions, especially when combined with a rotisserie (where possible). Also ideal for cooking sausages and bacon. |
|    | Microwave: Penetrating straight into the food, microwaves cook very quickly and with considerable energy savings. Suitable for cooking without fat, they are also able to thaw and heat food without altering its original appearance and aroma. The microwave function can also be combined with conventional functions with all the resulting advantages. Ideal for all types of food. |    | Microwave + grill element: The use of the grill results in a perfect browning of the surface of the food. The action of microwaves allows instead of cooking in a short time the internal part of the food.   |
|  | Touch controls: Easy to use touch controls allow the appliance to be programmed at the touch of a button.                                                                                                                                                                                                                                                                                |  | The capacity indicates the amount of usable space in the oven cavity in litres.                                                                                                                               |