







FMIU020X



Product Family	Microwave
Category	Built-in
Installation	With frame
Power supply	Electric
Cooking Method	Microwave with grill
Control	Electromechanical



Programs / Functions

No. of functions	6
Full grill	
Pizza	
Defrost by time	
Defrost by weight	
Microwave	
Microwave + grill	
Automatic programmes	8

Controls

Display / Clock	1 a LED	No. of controls	1
Type of control setting	Control knobs / buttons	Control knobs	Push-push
Opening	Mechanical button	Controls colour	Steel effect

Options



Timer	Electronic	Controls Lock / Child Safety	Yes
Time-setting options	End cooking	Quick start option	Yes
End of cooking acoustic alarm	Yes		

Technical Features



Cavity material	Stainless steel	Grill - power	1000 W
No. of lights	1	Total no. of door glasses	1
Light type	Led	Safety Thermostat	Yes
Turntable	Yes	Cooling system	Tangential
Turntable dimensions	24.5 "	Microwave screen protection	Yes
Light when door is opened	Yes	Microwave stops when door is opened	Yes
Grill type	Heating element	Microwave effective power	800 W

Accessories Included







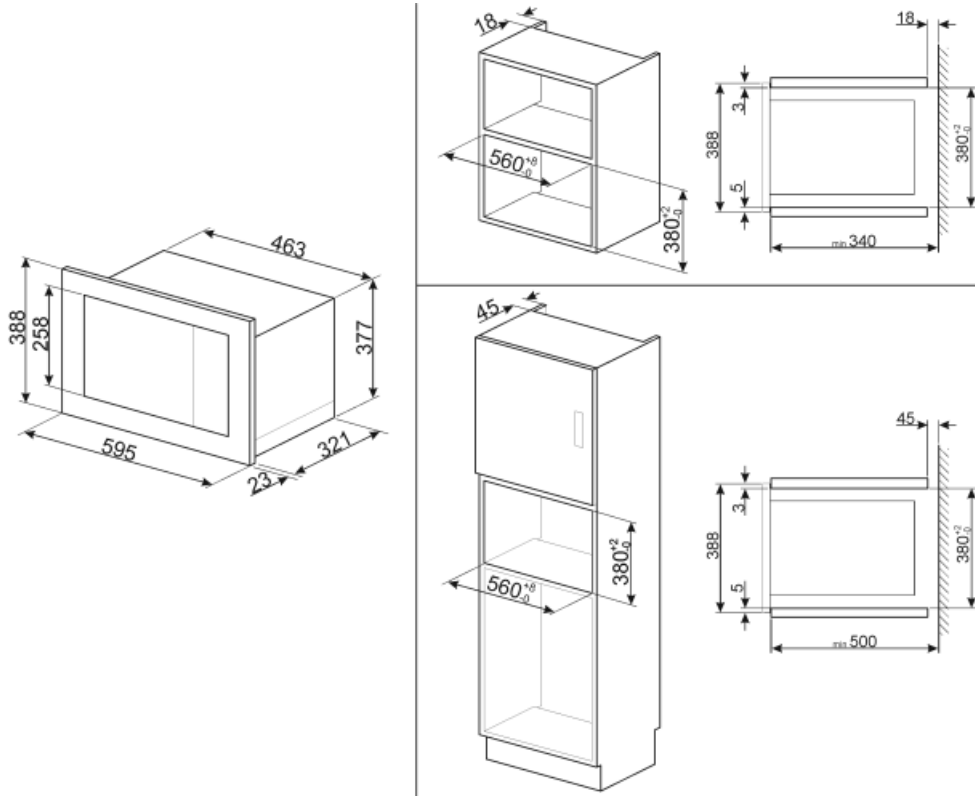



Grid	1	Frame	Yes
-------------	---	--------------	-----

Electrical Connection

Nominal power	1350 W	Frequency (Hz)	60 Hz
Current	11 A	Power supply cable length	59 1/16 "
Voltage (V)	120 V		



Symbols glossary (TT)

	Child lock: some models are fitted with a device to lock the programme/cycle so it cannot be accidentally changed.		Microwave energy shortens cooking times dramatically and produces energy savings.
	Defrost by time: Manual defrost function. At the end of the set duration, the function stops.		Defrost by weight: Automatic defrost function. You choose the type of food to defrost from the available categories (MEAT - FISH - BREAD - DESSERTS) After entering the weight of the food, the oven automatically defines the time required for proper defrosting.
	Grill: Very intense heat coming only from above from a double heating element. The fan is not active. Provides excellent grilling and gratinating results. Used at the end of cooking, it gives a uniform browning to dishes.		Microwave: Penetrating straight into the food, microwaves cook very quickly and with considerable energy savings. Suitable for cooking without fat, they are also able to thaw and heat food without altering its original appearance and aroma. The microwave function can also be combined with conventional functions with all the resulting advantages. Ideal for all types of food.
	Microwave + grill element: The use of the grill results in a perfect browning of the surface of the food. The action of microwaves allows instead of cooking in a short time the internal part of the food.		Pizza microwave: This function cooks pizza quicker thanks to the microwaves. To optimize the final result, use the function combined with the Chef plate
	Side lights: Two opposing side lights increase visibility inside the oven.		The capacity indicates the amount of usable space in the oven cavity in litres.