

FQ50UFXE



Product family	Refrigerator
Installation	Free-standing
Category	2 doors & 2 drawers
No-frost system	Total
Cooling type	Fan-assisted refrigerator, no-frost freezer
Defrost	Automatic
Hinge	Standard
EAN code	8017709255275



Aesthetic



Aesthetics	Universal	Logo color	Silver
Color	Stainless steel	Side material	Steel
Finishing	Fingerprint-proof	Side color	Silver
Design	Flat	Logo	Applied
Material	Steel	Door shelf profile color	Silver
Door stainless steel type	Fingerprint-proof	Drawers profile color	Silver
Handle	External	Glass shelf profile color	White
Handle	Fixed	Display	LCD touch
Handle color	Stainless steel	Display position	

Refrigerator compartment features



No. of adjustable shelves	2	Type of crisper cover	Glass
Number of fruit and vegetables drawers	2	LifePlus zone - 32°F	Yes
Type of adjustable shelves	Glass	Refrigerator lighting	Yes
Crisper drawer type	Standard	Refrigerator lighting	LED
Crisper cover	Yes		

Refrigerator Inner Door

No. of door shelves with transparent cover 2
 Number of adjustable door shelves 4

No. of bottle shelves 2

Other Refrigerator features



Accessories
 MultiFlow

Egg tray
 Yes

Fan

Yes

Freezer features

Number of drawers 2

Other Freezer features

Ice maker Automatic

Ice-tray shelf Yes

Other technical features



Display functions

Holiday, Fast-freezing, Child lock, Temperature alarm

MultiZone

Yes

Fast-freezing button

Yes

Water network connection

Door open alarm

Acoustic

Temperature Alarm

Yes

Temperature setting type

Electronic

No. of compressors

1

Refrigerant gas type

R134a

Compressor type

Standard

Refrigerant quantity

6.3 oz

Foam agent

Cyclopentane

Performance / Energy Label

Noise level 45 dB(A) re 1 pW

Electrical Connection

Plug (A) USA & Mexico

Voltage (V) 115 V

Electrical connection rating 160 W







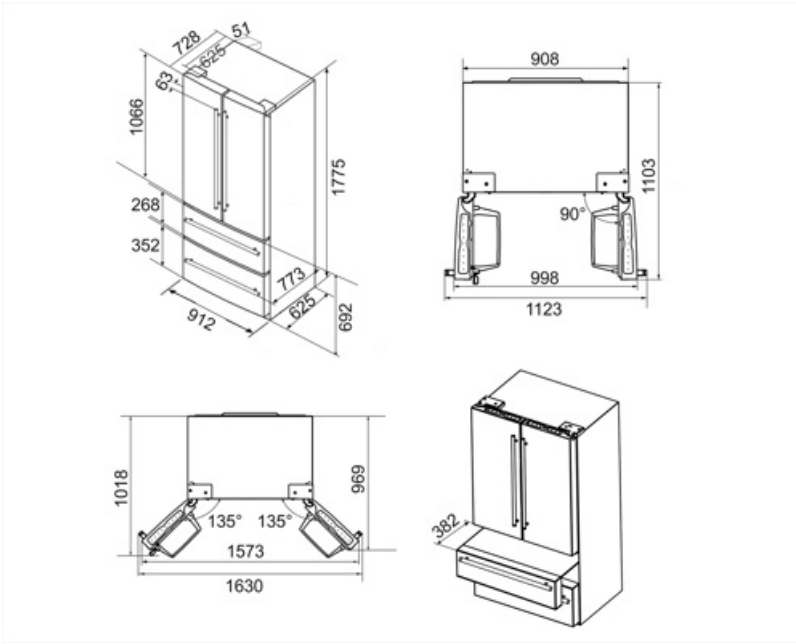





Frequency (Hz) 60 Hz

Current 2.7 A

Power cord length 66 15/16 "



Symbols glossary

	4 stars freezing compartment for better food preservation.		The automatic defrost system works by automatically defrosting at regular intervals eliminating the need to defrost altogether.
	Child lock: some models are fitted with a device to lock the programme/cycle so it cannot be accidentally changed.		LCD display: to optimize performance and simplify the use of the appliance.
	Ventilated: Forced distribution of cold air in the refrigerator compartment, which allows even temperature distribution within the fridge.		Fast freezing: The fast freezing function brings the temperature of the compartment down when activated a few hours prior to usage.
	Fingerprint proof stainless steel: Fingerprint proof stainless steel keeps stainless steel looking as good as new.		Power saving mode: The power saving mode allows you to disable the refrigerator and keep the freezer working.
	LED interior lighting: is a more energy efficient and long lasting way of illuminating the interior of the appliance.		Life Plus 0°C: The temperature in the Lifeplus compartments is kept at 0°C, which preserves fresh meat and fish longer.
	Air plus: keeps food fresher for longer.		No Frost: The No Frost and Frost free systems prevent ice from forming so that no defrosting is required.

Benefit (TT)

Plastic multifold system

The Multiflow system ensures even distribution of cold air inside the refrigerator

Fan

The fan contributes to an even distribution of air inside the refrigerator

Multizone (variable temperature compartment)

The Multizone system isolates a freezer compartment with adjustable temperature independent of the main compartment, to give maximum storage flexibility

The Multizone compartment can be used both as a freezer and as a refrigerator. Depending on one's needs and eating habits, each user can choose how to set it, programming the temperature via the external display.

External handle

The external handle ensures practicality and ease of use of the refrigerator

Life Plus 0°

Temperature-controlled Life Plus compartment for optimal storage of specific food categories

Refrigerator Internal lighting

Interior lighting for perfect visibility of shelves in the refrigerator compartment

Fruit and vegetable drawer

The fruit and vegetable drawer ensures the best storage conditions for fresh food, avoiding any contamination

Automatic Ice Maker

Automatic ice maker for ice always available when needed

The automatic ice maker is connected directly to the kitchen water supply, so there is no need to manually fill any tanks. This saves considerable time and ensures hygiene and convenience.