

FQ55FNDF



| | |
|------------------|---|
| Product familie | Koelkast |
| Installatie | Vrijstaand |
| Categorie | Koel-vriescombinatie met 2 deuren en 2 schuiven |
| Reference width | Meer dan 80 cm |
| No Frost systeem | Totaal No-Frost |
| Type koelen | Geventileerde koelkast, No Frost vriezer |
| Ontdooien | Automatisch ontdooien |
| Type scharnier | Standaard |
| EAN-code | 8017709293284 |



Design



| | | | |
|-----------------|------------|------------------------------|--------------------|
| Design | Universeel | Materiaal zijwanden | Staal |
| Kleur | Zwart | Kleur zijkanten | Zwart |
| Afwerking | Glanzend | Logo | Geassembleerd |
| Design | Plat | Kleur profielen binnenzijde | Zilver |
| Materiaal deur | Plaatstaal | Kleur profielen laden | Zilver |
| Handgreep | Extern | Kleur profiel glazen leggers | Zilver |
| Type handgreep | Vast | Display | LED |
| Kleur handgreep | Zwart | Positie display | Esterno (su porta) |
| Kleur logo | Chroom | | |

Uitrusting koelkast



| | | | |
|------------------------------------|----------------------------|------------------------------------|------|
| Aantal verstelbare leggers | 3 | Afdekplaat groentelade | Ja |
| Aantal groente-/fruitlades | 2 | Type afdekplaat groente-/fruitlade | Glas |
| Type verstelbare leggers | Glas | Binnenverlichting koelkast | Ja |
| Type afdekplaat groente-/fruitlade | Op telescopische geleiders | Type binnenverlichting koelkast | LED |

Binnendeur koelkast

Aantal flessenhouders 2

| | | | |
|---|----|------------------------------------|----|
| Aantal binnendeurcompartimenten met transparante deksel | 2 | Flessenhouders met metalen steunen | Ja |
| Aantal verstelbare binnendeurcompartimenten | 4 | | |
| Binnendeurcompartimenten met metalen steunen | Ja | | |

Overige features koelkast



| | | | |
|-------------------------|------------|----------------------------|----|
| Accessoires | Eierhouder | Ventilator | Ja |
| Natural Plus Blue Light | Ja | Active Ion technology | Ja |
| MultiFlow | Ja | Anti bacteriële geurfilter | Ja |

Uitrusting vriezer

| | |
|--------------|---|
| Aantal lades | 2 |
|--------------|---|

Overige features vriezer



| | | | |
|-------------|-------------------|------------------------|----|
| Accessoires | 1 ijsblokeshouder | Snel-vriescompartiment | Ja |
|-------------|-------------------|------------------------|----|

Overige technische eigenschappen

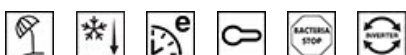

| | |
|--------------------------|--|
| Display functies | Vakantiefunctie, Snel-vriesfunctie, Snel-koelfunctie, ECO, Kinderbeveiliging |
| Snel-vriestoets | Ja |
| Alarm open deur | Ja |
| Temperature Alarm | Ja |
| Anti bacteriële pakking | Ja |
| Type temperatuurcontrole | Elektronisch |
| Aantal compressoren | 1 |
| Type koelgas | R600a |
| Type compressor | Variabele toeren |
| Hoeveelheid koelmiddel | 63 g |
| Schuimmiddel | Cyclopentaan |

Prestaties/Energie label - Reg. 2019



| | | | |
|---------------------------|--------------|---------------|-----------------|
| Annual energy consumption | 378 KWh/jaar | Geluidsniveau | 35 dB(A) re 1pW |
|---------------------------|--------------|---------------|-----------------|







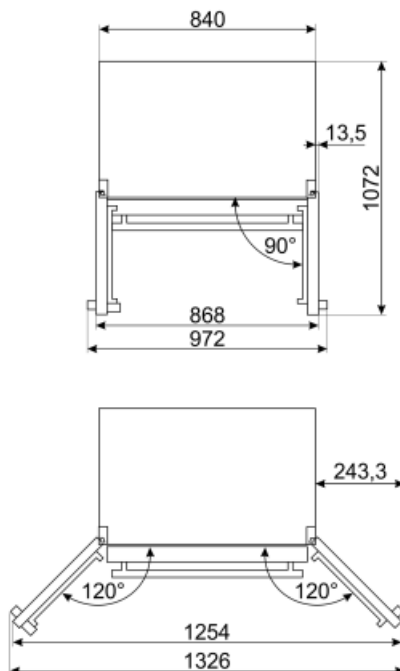
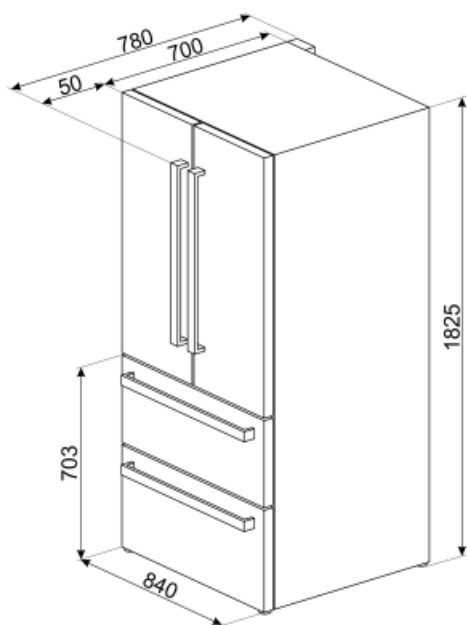









| | | | |
|---|-------|---------------------------------|-------------|
| Energie-efficiëntieklasse | F | Conserveringsduur zonder stroom | 18 h |
| Emissieklasse voor akoestisch luchtgeluid | B | 4 star - Freezing capacity | 10.7 Kg/24h |
| Totaal netto volume | 539 l | Klimaatklasse | SN, ST |
| Netto inhoud vriesgedeelte | 152 l | EI | 125 % |
| Netto inhoud koelgedeeltes | 387 l | | |

Elektrische aansluiting

| | | | |
|-------------------------|--------------|--------------------|--------|
| Stekker | (F;E) Schuko | Spanning (V) | 230 V |
| Nominale aansluitwaarde | 160 W | Frequentie (Hz) | 50 Hz |
| Stroom (A) | 0,9 A | Lengte stroomkabel | 240 cm |



Symbols glossary (TT)

| | |
|--|---|
|  <p>4 stars freezing compartment for better food preservation.</p> |  <p>A++: Energy efficiency class A++ helps to save up to 20% energy compared to class A. Maximum performance with minimum consumption is guaranteed.</p> |
|  <p>Smeg Active Ion system improves the quality of the air inside the cell. Thanks to the generation of negatively charged ions released inside the fridge Active Ion system neutralizes unpleasant dust.</p> |  <p>The automatic defrost system works by automatically defrosting at regular intervals eliminating the need to defrost altogether.</p> |
|  <p>Antibacterial treatment: antibacterial treatment to ensure better hygiene</p> |  <p>Sommige modellen zijn voorzien van een functie om het programma/de cyclus te blokkeren zodat het niet per ongeluk kan aangepast worden.</p> |
|  <p>LED display: to show programmes, functions and options selected and the time to the end of the cycle.</p> |  <p>Economical mode: Analyzes fridge functioning during the activation and optimizes the operating cycle in order to reduce power consumption.</p> |
|  <p>Geventileerd: een geforceerde verdeling van koude lucht in het koelkast compartiment, die een gelijke temperatuurverdeling verzekert in de koelkast.</p> |  <p>Fast freezing: The fast freezing function brings the temperature of the compartment down when activated a few hours prior to usage.</p> |
|  <p>Power saving mode: The power saving mode allows you to disable the refrigerator and keep the freezer working.</p> |  <p>LED interior lighting: is a more energy efficient and long lasting way of illuminating the interior of the appliance.</p> |
|  <p>De evolutie van Smeg vaatwassers naar meer intelligente en milieuvriendelijke modellen heeft ertoe geleid om de inverter technologie te gebruiken, die een significante energie- en geluidsbesparing met zich meebrengt.</p> |  <p>Air plus: keeps food fresher for longer.</p> |
|  <p>Natural Plus Blue Light: Dit unieke Natural Plus Blue Light-systeem verlengt de bewaartijd van groenten en fruit</p> |  <p>No Frost: The No Frost and Frost free systems prevent ice from forming so that no defrosting is required.</p> |
|  <p>Energie-efficiëntieklasse</p> | |