

FQ55FXDE



Product familie	Koelkast
Installatie	Vrijstaand
Categorie	Koel-vriescombinatie met 2 deuren en 2 schuiven
Referentie breedte	Meer dan 80 cm
Referentie hoogte	160 - 200 cm
No Frost systeem	Totaal No-Frost
Type koelen	Geventileerde koelkast, No Frost vriezer
Ontdooien	Automatisch ontdooien
Type scharnier	Standaard
EAN-code	8017709337643



Design



Design	Universeel	Kleur logo	Chroom
Kleur	Inox-look	Materiaal zijwanden	Staal
Design	Plat	Kleur zijkanten	Zilver
Handgreep	Extern	Logo	Geassembleerd
Type handgreep	Vast	Display	LED
Kleur handgreep	Inox	Positie display	Esterno (su porta)

Uitrusting koelkast



Aantal verstelbare leggers	3	Afdekplaat groentenlade	Ja
Aantal groente-/fruitlades	2	Type afdekplaat groente-/fruitlade	Glas
Type verstelbare leggers	Glas	Binnenverlichting koelkast	Ja
Type afdekplaat groente-/fruitlade	Standaard	Type binnenverlichting koelkast	LED

Binnendeur koelkast

Aantal binnendeurcompartimenten met transparante deksel	2	Aantal flessenhouders	2
Aantal verstelbare binnendeurcompartimenten	4	Flessenhouders met metalen steunen	Ja

Binnendeurcompartimenten Ja
met metalen steunen

Overige features koelkast



Accessoires	Eierhouder	Ventilator	Ja
Natural Plus Blue Light	Ja	Active Ion technology	Ja
MultiFlow	Ja	Anti bacteriële geurfilter	Ja

Uitrusting vriezer

Aantal lades 2

Overige features vriezer



Accessoires	1 ijsblokeshouder	Snel-vriescompartiment	Ja
-------------	-------------------	------------------------	----

Overige technische eigenschappen

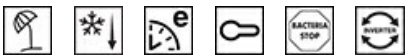

Display functies	Vakantiefunctie, Snel-vriesfunctie, Snel-koelfunctie, ECO, Kinderbeveiliging, Temperatuuralarm
Snel-vriestoets	Ja
Alarm open deur	Ja
Temperature Alarm	Ja
Anti bacteriële pakking	Ja
Type temperatuurcontrole	Elektronisch
Aantal compressoren	1
Type koelgas	R600a
Type compressor	Variabele toeren
Schuimmiddel	Cyclopentaan

Prestaties/Energie label - Reg. 2019



Annual energy consumption	302 KWh/jaar	Geluidsniveau	35 dB(A) re 1 pW
Energie-efficiëntieklasse	E	Conserveringsduur zonder stroom	18 h
Emissieklasse voor akoestisch luchtgeluid	B	4 star - Freezing capacity	10.7 Kg/24h
Totaal netto volume	539 l	Klimaatklasse	SN, N, ST
Netto inhoud vriesgedeelte	152 l	EEl	100 %







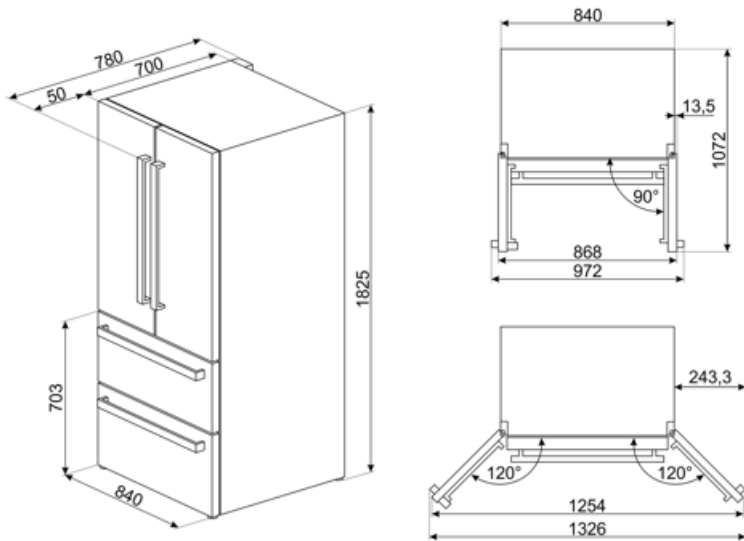







Netto inhoud 387 l
koelgedeeltes

Elektrische aansluiting

Stekker	(F;E) Schuko	Spanning (V)	220-240 V
Nominale aansluitwaarde	160 W	Frequentie (Hz)	50 Hz
Stroom (A)	0,9 A	Lengte stroomkabel	240 cm



Symbols glossary

	<p>Smeg Active Ion system improves the quality of the air inside the cell. Thanks to the generation of negatively charged ions released inside the fridge Active Ion system neutralizes unpleasant dust.</p>		<p>The automatic defrost system works by automatically defrosting at regular intervals eliminating the need to defrost altogether.</p>
	<p>Antibacterial treatment: antibacterial treatment to ensure better hygiene</p>		<p>Sommige modellen zijn voorzien van een functie om het programma/de cyclus te blokkeren zodat het niet per ongeluk kan aangepast worden.</p>
	<p>LED display: to show programmes, functions and options selected and the time to the end of the cycle.</p>		<p>Economical mode: Analyzes fridge functioning during the activation and optimizes the operating cycle in order to reduce power consumption.</p>
	<p>Geventileerd: een geforceerde verdeling van koude lucht in het koelkast compartiment, die een gelijke temperatuurverdeling verzekert in de koelkast.</p>		<p>Fast freezing: The fast freezing function brings the temperature of the compartment down when activated a few hours prior to usage.</p>
	<p>Power saving mode: The power saving mode allows you to disable the refrigerator and keep the freezer working.</p>		<p>LED interior lighting: is a more energy efficient and long lasting way of illuminating the interior of the appliance.</p>
	<p>De evolutie van Smeg vaatwassers naar meer intelligente en milieuvriendelijke modellen heeft ertoe geleid om de inverter technologie te gebruiken, die een significante energie- en geluidsbesparing met zich meebrengt.</p>		<p>Multiflow Cooling System: the Multiflow ventilation system allows an even distribution of cool air around the fridge cabinet.</p>
	<p>Natural Plus Blue Light: Dit unieke Natural Plus Blue Light-systeem verlengt de bewaartijd van groenten en fruit</p>		<p>No Frost: The No Frost and Frost free systems prevent ice from forming so that no defrosting is required.</p>
	<p>Energie-efficiëntieklasse</p>		

Benefit (TT)

Natural Plus Blue Light

The Natural plus Blue light system extends the shelf life of fruit and vegetables while preserving their organoleptic properties

Plastic multiflow system

The Multiflow system ensures even distribution of cold air inside the refrigerator

Fan

The fan contributes to an even distribution of air inside the refrigerator

Refrigerant gas R600a

Environmentally friendly R600a refrigerant gas contributes to rapid cooling with lower energy consumption

External handle

The external handle ensures practicality and ease of use of the refrigerator

Refrigerator Internal lighting

Interior lighting for perfect visibility of shelves in the refrigerator compartment

Fruit and vegetable drawer

The fruit and vegetable drawer ensures the best storage conditions for fresh food, avoiding any contamination

Inverter compressor

Inverter compressor reduces noise and vibration levels for a quiet and comfortable kitchen environment

Inverter compressor technology offers significant advantages for refrigeration systems, improving both performance and efficiency. Better temperature control ensures a more stable and constant indoor environment, preserving the freshness of food. This technology also results in reduced energy consumption, as the compressor adjusts its speed according to cooling needs.

External display

External display for simple and intuitive control with quick access to information