

# FQ55FXDF



Product Family	Refrigerator
Installation	Free standing
Category	2 Doors & 2 Drawers
Reference width	Higher than 80
Sistema Total No - Frost	Total
Cooling type	Fan assisted refrigerator, no-frost freezer
Defrost	Automatic
Hinge type	Standard
EAN code	8017709293277



## Aesthetics



Aesthetic	Universale	Logo colour	Chrome
Colour	Inox-look	Side material	Steel
Design	Flat	Side colour	Silver
Handle	External	Logo	Applied
Handle type	Fixed	Display	LED
Handle colour	Stainless steel	Display position	Esterno (su porta)

## Refrigerator compartment features



No. of adjustable shelves	3	Crisper Cover	Yes
Number of fruit and vegetables drawers	2	Type of crisper/vegetable drawers cover	Glass
Type of adjustable shelves	Glass	Internal light in fridge	Yes
Type of crisper/vegetable drawers cover	Standard	Type of internal light (fridge)	LED

## Refrigerator Inner Door

No. of door shelves with transparent cover	2	No. of bottle shelves	2
Number of adjustable door shelves	4	Bottle shelves with wire support	Yes

Adjustable door shelves Yes  
with wire support

## Other Refrigerator features



Accessories	Egg tray	Fan	Yes
Natural Plus Blu Light	Yes	Ionizer	Yes
MultiFlow	Yes	Antibacterial odour filter	Yes

## Freezer compartment features

Number of drawers 2

## Other Freezer features



Accessories	2 ice boxes	Fast freezing compartment	Yes
-------------	-------------	---------------------------	-----

## Other technical features

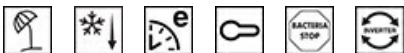

Functions display	Holiday, Fast freezing, Fast cooling, ECO, Control lock, Temperature alarm
Fast freezing button	Yes
Door open alarm	Yes
Temperature Alarm	Yes
Antibacterial Gasket	Yes
Type of temperature control	Electronic
No. of compressors	1
Refrigerant gas type	R600a
Type of compressor	Inverter
Refrigerant Quantity (gr)	61 g
Foam agent	Cyclopentane

## Performance / Energy Label - Reg. 2019



Annual energy consumption	378 kWh/a	Airborne acoustical noise emissions	35 dB(A) re 1 pW
Energy efficiency class	F	Temperature Rise Time	18 h
Airborne acoustical noise emission class	B	4 star - Freezing capacity	10.7 Kg/24h
Total net volume	539 l	Climate class	SN, ST

Sum of the volumes of the frozen compartment(s) 152 l

EEl

125 %

Sum of the volumes of the chill compartment(s) and the unfrozen compartment(s) 387 l







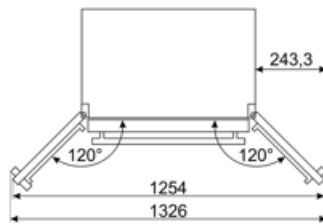
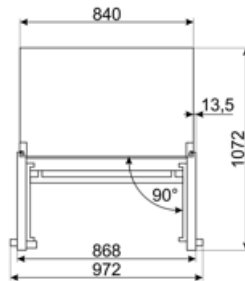
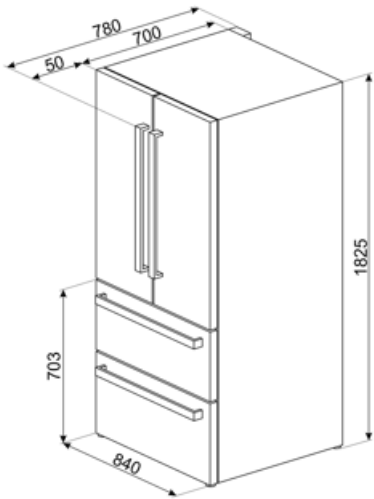









## Electrical Connection

Plug (F;E) Schuko  
 Electrical connection rating 160 W  
 Current 0,9 A

Voltage (V) 220-240 V  
 Frequency (Hz) 50 Hz  
 Power supply cable length 240 cm



## Symbols glossary

 <p>4 stars freezing compartment for better food preservation.</p>	 <p>A+: Energy efficiency class A+ helps to save up to 10% energy compared to class A. Maximum performance with minimum consumption is guaranteed.</p>
 <p>Smeg Active Ion system improves the quality of the air inside the cell. Thanks to the generation of negatively charged ions released inside the fridge Active Ion system neutralizes unpleasant dust.</p>	 <p>The automatic defrost system works by automatically defrosting at regular intervals eliminating the need to defrost altogether.</p>
 <p>Antibacterial treatment: antibacterial treatment to ensure better hygiene</p>	 <p>Child lock: some models are fitted with a device to lock the programme/cycle so it cannot be accidentally changed.</p>
 <p>LED display: to show programmes, functions and options selected and the time to the end of the cycle.</p>	 <p>Economical mode: Analyzes fridge functioning during the activation and optimizes the operating cycle in order to reduce power consumption.</p>
 <p>Ventilated: Forced distribution of cold air in the refrigerator compartment, which allows even temperature distribution within the fridge.</p>	 <p>Fast freezing: The fast freezing function brings the temperature of the compartment down when activated a few hours prior to usage.</p>
 <p>Power saving mode: The power saving mode allows you to disable the refrigerator and keep the freezer working.</p>	 <p>LED interior lighting: is a more energy efficient and long lasting way of illuminating the interior of the appliance.</p>
 <p>Smeg's evolution towards more intelligent and eco-friendly models has led to the choice of Inverter technology, which significantly reduces consumption.</p>	 <p>Multiflow Cooling System: the Multiflow ventilation system allows an even distribution of cool air around the fridge cabinet.</p>
 <p>Natural Plus Blu Light: This unique Natural Plus Blu Light system works with nature to increase the storage time of fruit and vegetables.</p>	 <p>No Frost: The No Frost and Frost free systems prevent ice from forming so that no defrosting is required.</p>
 <p>Energy efficiency class F</p>	