

FQ55FXE1



Product Family	Refrigerator
Installation	Free standing
Category	2 Doors & 2 Drawers
Sistema Total No - Frost	Total
Cooling type	Fan assisted refrigerator, no-frost freezer
Defrost	Automatic
Hinge type	Standard
EAN code	8017709221522



Aesthetics



Aesthetic	Universale	Handle colour	Stainless steel
Colour	Stainless steel	Logo colour	Chrome
Design	Flat	Side material	Steel
Finishing	Fingerproof	Side colour	Silver
Material	Stainless steel	Logo	Applied
Door steel type	Finger proof	Display	LED
Handle	External	Display position	
Handle type	Fixed		

Refrigerator compartment features



Shelves material	Glass	Life Plus zone-0°C	Yes
Type of crisper/vegetable drawers cover	Standard	Internal light in fridge	Yes
Crisper Cover	Yes	Type of internal light (fridge)	LED
Type of crisper/vegetable drawers cover	Glass		

Refrigerator Inner Door

No. of door shelves with transparent cover	2	No. of bottle shelves	2
---------------------------------------------------	---	------------------------------	---

Number of adjustable door shelves	4	Bottle shelves with wire support	Yes
Adjustable door shelves with wire support	Yes		

Other Refrigerator features



Accessories	Egg tray	Fan Ionizer	Yes
Natural Plus Blu Light	Yes	Antibacterial odour filter	Yes
MultiFlow	Yes		

Freezer compartment features

Number of drawers	2
-------------------	---

Other Freezer features



Accessories	2 ice boxes	Fast freezing compartment	Yes
-------------	-------------	---------------------------	-----

Other technical features



Functions display	Holiday, Fast freezing, Fast cooling, ECO, Control lock, Temperature alarm
Fast freezing button	Yes
Door open alarm	Visual
Temperature Alarm	Visual
Antibacterial Gasket	Yes
Type of temperature control	Electronic
No. of compressors	1
Refrigerant gas type	R600a
Type of compressor	Standard
Refrigerant Quantity (g)	61 g
Foam agent	Cyclopentane

Performance / Energy Label - Reg. 2019

Airborne acoustical noise emissions	42 dB(A) re 1 pW
-------------------------------------	------------------

Electrical Connection







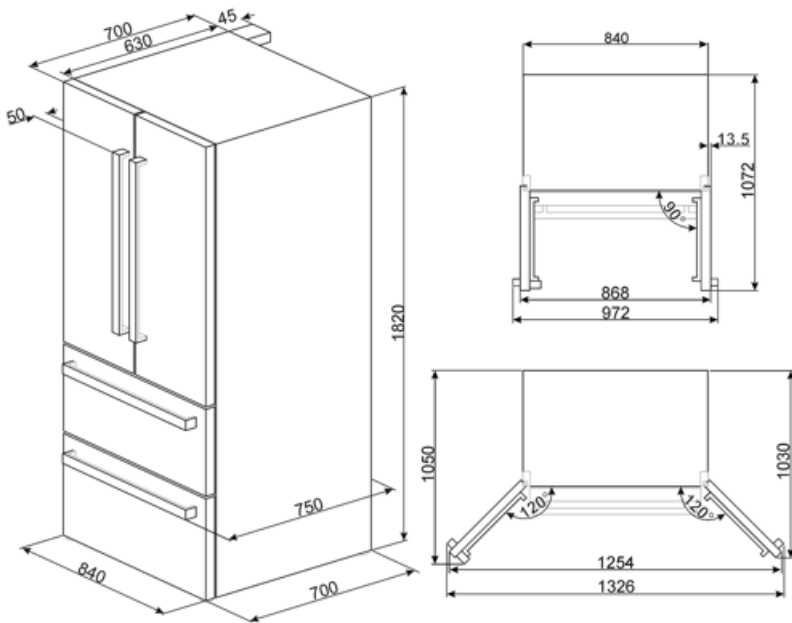









Electrical connection rating	160 W	Frequency (Hz)	50 Hz
Current	0.9 A	Power supply cable length	240 cm
Voltage (V)	220-240 V	Plug	(F;E) Schuko

Logistic Information

Width	840 mm	Product depth with handle	750 mm
Depth without handle	700 mm	Product depth with doors open at 90°	1072 mm
Height	1820 mm	Spacer depth	45 mm
Product width with maximum doors opening	1512 mm		



Symbols glossary

 <p>4 stars freezing compartment for better food preservation.</p>	 <p>Smeg Active Ion system improves the quality of the air inside the cell. Thanks to the generation of negatively charged ions released inside the fridge Active Ion system neutralizes unpleasant dust.</p>
 <p>The automatic defrost system works by automatically defrosting at regular intervals eliminating the need to defrost altogether.</p>	 <p>Antibacterial treatment: antibacterial treatment to ensure better hygiene.</p>
 <p>Child lock: some models are fitted with a device to lock the programme/cycle so it cannot be accidentally changed.</p>	 <p>A+: Energy efficiency class A+ helps to save up to 10% energy compared to class A. Maximum performance with minimum consumption is guaranteed.</p>
 <p>LED display: to show programmes, functions and options selected and the time to the end of the cycle.</p>	 <p>Economical mode: Analyzes fridge functioning during the activation and optimizes the operating cycle in order to reduce power consumption.</p>
 <p>Ventilated: Forced distribution of cold air in the refrigerator compartment, which allows even temperature distribution within the fridge.</p>	 <p>Fast freezing: The fast freezing function brings the temperature of the compartment down when activated a few hours prior to usage.</p>
 <p>Fingerprint proof stainless steel: Fingerprint proof stainless steel keeps stainless steel looking as good as new.</p>	 <p>Power saving mode: The power saving mode allows you to disable the refrigerator and keep the freezer working.</p>
 <p>LED interior lighting: is a more energy efficient and long lasting way of illuminating the interior of the appliance.</p>	 <p>Life Plus 0°C: The temperature in the Lifeplus compartments is kept at 0°C, which preserves fresh meat and fish longer.</p>
 <p>Multiflow Cooling System: the Multiflow ventilation system allows an even distribution of cool air around the fridge cabinet.</p>	 <p>Natural Plus Blu Light: This unique Natural Plus Blu Light system works with nature to increase the storage time of fruit and vegetables.</p>
 <p>No Frost: The No Frost and Frost free systems prevent ice from forming so that no defrosting is required.</p>	