

FQ60BDE



| | |
|--------------------|-----------------------------------|
| Product familie | Koelkast |
| Installatie | Vrijstaand |
| Categorie | Koel-vriescombinatie met 4 deuren |
| Referentie breedte | Meer dan 80 cm cm |
| Referentie hoogte | 160 - 200 cm cm |
| No Frost systeem | Ja |
| Type koelen | Dubbel koelsysteem |
| Ontdooien | Automatisch ontdooien |
| Type scharnier | Standaard |
| EAN-code | 8017709337681 |



Design



| | | | |
|---------------------|------------|------------------------------|--------------------|
| Design | Universeel | Kleur zijkanten | Wit |
| Kleur | Wit | Logo | Geassembleerd |
| Design | Plat | Kleur profielen binnenzijde | Zilver |
| Materiaal deur | Plaatstaal | Kleur profielen laden | Zilver |
| Handgreep | Extern | Kleur profiel glazen leggers | Zilver |
| Type handgreep | Vast | Display | LED |
| Kleur handgreep | Zilver | Positie display | Esterno (su porta) |
| Kleur logo | Chroom | Beschikbare kleuren | Inox, Zwart |
| Materiaal zijwanden | Staal | | |

Uitrusting koelkast



| | | | |
|------------------------------------|--|------------------------------------|------|
| Number of compartments | 3 | Afdekplaat groentenlade | Ja |
| Compartment types | Low temperature compartment, Fruit and vegetable compartment | Type afdekplaat groente-/fruitlade | Glas |
| Aantal verstelbare leggers | 2 | Aantal lampen | 2 |
| Aantal groente-/fruitlades | 2 | Low temperature compartment | Ja |
| Shelves material | Glas | Binnenverlichting koelkast | Ja |
| Type afdekplaat groente-/fruitlade | Op telescopische geleiders | Type binnenverlichting koelkast | LED |

Binnendeur koelkast

| | | | |
|---|---|-----------------------|---|
| Aantal binnendeurcompartimenten met transparante deksel | 2 | Aantal flessenhouders | 2 |
| Aantal verstelbare binnendeurcompartimenten | 2 | | |

Overige features koelkast



| | | | |
|-------------------------|-------------|----------------------|----|
| Humidity Control | Yes, manual | MultiFlow Ventilator | Ja |
| Accessoires | Eierhouder | | |
| Natural Plus Blue Light | Ja | | |

Uitrusting vriezer

| | | | |
|-------------------|---|--------------|------|
| Aantal lades | 4 | Type leggers | Glas |
| Aantal legplanken | 2 | | |

Overige features vriezer



| | | | |
|-------------|---------------------|-----------------------|----|
| Accessoires | 2 ijsblokjeshouders | Snel-vriescompartment | Ja |
|-------------|---------------------|-----------------------|----|

Overige technische eigenschappen



| | |
|-------------------------------------|--|
| Display functies | Vakantiefunctie, Snel-vriesfunctie, Snel-koelfunctie, ECO, Kinderbeveiliging |
| Snel-vriestoets | Ja |
| Indicator (lampje) temperatuuralarm | Ja |
| Alarm open deur | Ja |
| Temperature Alarm | Ja |
| Anti bacteriële pakking | Ja |
| Type temperatuurcontrole | Elektronisch |
| Aantal compressoren | 1 |
| Type koelgas | R600a |
| Type compressor | Variabele toeren |
| Schuimmiddel | Cyclopentaan |

Prestaties/Energie label - Reg. 2019



| | | | |
|--|--------------|---|------------------|
| Annual energy consumption | 406 kWh/jaar | Geluidsniveau | 37 dB(A) re 1 pW |
| Energie-efficiëntieklasse | E | Conserveringsduur zonder stroom | 10 h |
| Emissieklasse voor akoestisch luchtgeluid | C | 4 star - Freezing capacity | 4.6 kg/24h |
| Totaal netto volume | 572 l | Freezer (4-star) (1) - Freezing capacity | 4.6 kg/24h |
| Netto inhoud vriesgedeelte | 196 l | Klimaatklasse | SN, N, ST, T |
| Netto inhoud koelgedeeltes | 376 l | EEl | 100 % |

Elektrische aansluiting

| | | | |
|--------------------------------|-------|---------------------------|--------------|
| Nominale aansluitwaarde | 200 W | Frequentie (Hz) | 50 Hz |
| Stroom (A) | 0.8 A | Lengte stroomkabel | 240 cm |
| Spanning (V) | 230 V | Stekker | (F;E) Schuko |

Logistieke informatie

| | | | |
|--|--------|---|---------|
| Breedte product (mm) | 908 mm | Maximum hoogte | 1820 mm |
| Diepte zonder handvat en spacer | 750 mm | Product breedte met maximale deuropening | 1634 mm |

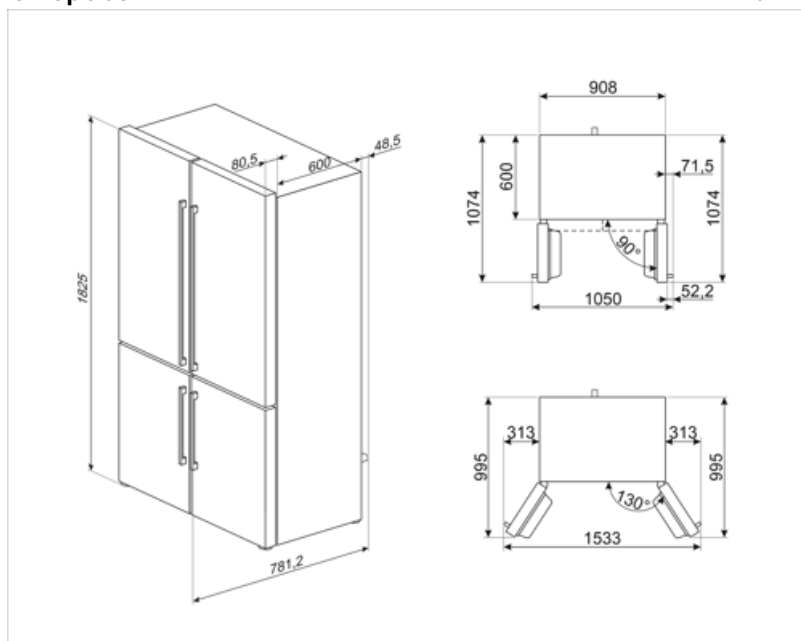













Alternative products



FQ60NDE

Zwart

Symbols glossary

| | | | |
|--|--|--|--|
|  | The automatic defrost system works by automatically defrosting at regular intervals eliminating the need to defrost altogether. |  | Antibacterial treatment: antibacterial treatment to ensure better hygiene. |
|  | Sommige modellen zijn voorzien van een functie om het programma/de cyclus te blokkeren zodat het niet per ongeluk kan aangepast worden. |  | Energie-efficiëntieklasse |
|  | LED display: to show programmes, functions and options selected and the time to the end of the cycle. |  | Economical mode: Analyzes fridge functioning during the activation and optimizes the operating cycle in order to reduce power consumption. |
|  | Geventileerd: een geforceerde verdeling van koude lucht in het koelkast compartiment, die een gelijke temperatuurverdeling verzekert in de koelkast. |  | Fast freezing: The fast freezing function brings the temperature of the compartment down when activated a few hours prior to usage. |
|  | Power saving mode: The power saving mode allows you to disable the refrigerator and keep the freezer working. |  | LED interior lighting: is a more energy efficient and long lasting way of illuminating the interior of the appliance. |
|  | De evolutie van Smeg vaatwassers naar meer intelligente en milieuvriendelijke modellen heeft ertoe geleid om de inverter technologie te gebruiken, die een significante energie- en geluidsbesparing met zich meebrengt. |  | Multiflow Cooling System: the Multiflow ventilation system allows an even distribution of cool air around the fridge cabinet. |
|  | Natural Plus Blue Light: Dit unieke Natural Plus Blue Light-systeem verlengt de bewaartijd van groenten en fruit | | |