

FQ60BDF



Product Family	Refrigerator
Installation	Free Standing
Category	4 Doors
Reference width	Higher than 80
Sistema Total No - Frost	Total
Cooling type	Total sem geadá - Sistema de arrefecimento duplo
Defrost	Automatic
Hinge type	Standard
Door opening flush with the wall	No
EAN code	8017709293338



Aesthetics



Aesthetic	Universal	Logotipo	Logotipo aplicado
Colour	White	Cor do perfil das prateleiras da porta	Silver
Design	Flat	Cor do perfil das gavetas	Silver
Material	Metal sheet	Cor do perfil da prateleira de vidro	Silver
Handle kit to be ordered separately	No	Display	LED
Handle	External	Mostrar porções	Externo (na porta)
Handle type	Fixed	Dispenser	No
Handle colour	Silver	Water Filter	No
Logo colour	Chrome	HomeBar	No
Side material	Steel	Alternative colours available	Stainless steel, Black
Side colour	White		

Refrigerator compartment features

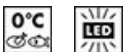

No. of adjustable shelves	2	Type of crisper/vegetable drawers cover	Glass
Number of fruit and vegetables drawers	2	Life Plus zone-0°C	Yes
Type of adjustable shelves	Glass	Compartimento baixa temperatura	No
		Internal light in fridge	Yes
		Type of internal light (fridge)	LED

Type of crisper/vegetable drawers cover On sliding rails

Crisper Cover Yes
Bottle shelf No

Refrigerator Inner Door

No. of door shelves with transparent cover 2

Number of adjustable door shelves 2

Adjustable door shelves with wire support No

No. of bottle shelves 2

Bottle shelves with wire support No

Other Refrigerator features



Accessories Egg tray
Natural Plus Blu Light Yes
MultiFlow Yes
Fan Yes

Ionizer Yes
Tecnologia de titânio No
Filtro de odor antibacteriano Yes
Zona de cuidados biológicos No

Freezer compartment features

Number of drawers 3
No. of shelves 2
Internal light in freezer Yes

Type of internal light (freezer) LED
Type of shelves Glass

Freezer Inner Door

Pizza box No

Other Freezer features



Manual ice maker Yes
Ice maker Manual

Fast freezing compartment Yes
Ice tray shelf No

Other technical features

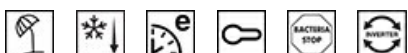

Functions display	Holiday, Fast freezing, Fast cooling, ECO, Control lock
MultiZone	No
Fast freezing button	Yes
Ligação à rede de água	No
Temperature alarm lamp	Yes
Door open alarm	Yes
Temperature Alarm	Yes
Antibacterial Gasket	Yes
Type of temperature control	Electronic
No. of compressors	1
Refrigerant gas type	R600a
Type of compressor	Inverter
Refrigerant Quantity (gr)	72 g
Espuma expansiva de isolamento	Ciclopentano

Etiqueta de Desempenho / Energia - Reg. 2019







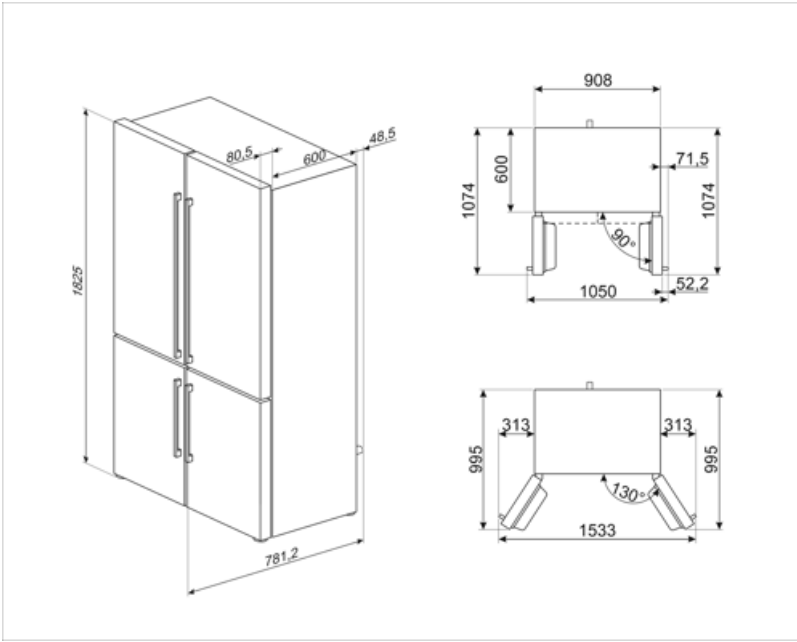









			
Consumo de energia anual	406 kWh/a	Airborne acoustical noise emissions	39 dB(A) re 1 pW
Classe de eficiência energética	F	Autonomia de conservação sem energia elétrica	10 h
Classe de emissão de ruído acústico aerotransportado	C	4 estrelas - Capacidade de congelamento	4.6 Kg/24h
Volume líquido total	572 l	4 estrelas - Capacidade de congelamento 1	4.6 Kg/24h
Soma dos volumes do(s) compartimento(s) congelado(s)	196 l	Classe climática	SN, T
Soma dos volumes do(s) compartimento(s) refrigerado(s) e do(s) compartimento(s) não congelado(s)	376 l	EEl	125 %

Electrical Connection

Plug	(F;E) Schuko	Voltage (V)	230 V
Electrical connection rating	200 W	Frequency (Hz)	50 Hz
Current	0,8 A	Power supply cable length	240 cm



Symbols glossary

	Compartimento de congelamento de 4 estrelas para uma melhor preservação dos alimentos.		A+: A classe de eficiência energética A+ ajuda a economizar até 10% de energia em comparação com a classe A. O desempenho máximo com consumo mínimo é garantido.
	Smeg Active Ion system improves the quality of the air inside the cell. Thanks to the generation of negatively charged ions released inside the fridge Active Ion system neutralizes unpleasant dust.		O sistema de descongelamento automático funciona descongelando automaticamente em intervalos regulares, eliminando a necessidade de descongelar completamente.
	Tratamento antibacteriano: tratamento antibacteriano para garantir uma melhor higiene		Bloqueio para crianças: alguns modelos estão equipados com um dispositivo para bloquear o programa/ciclo para que não possa ser acidentalmente alterado.
	Display LED: para mostrar os programas, funções e opções selecionadas e o tempo até ao final do ciclo.		Modo económico: Analisa o funcionamento da geladeira durante a ativação e otimiza o ciclo de funcionamento, a fim de reduzir o consumo de energia.
	Ventilado: Distribuição forçada de ar frio no compartimento da geladeira, o que permite uma distribuição uniforme da temperatura dentro da geladeira.		CONGELAMENTO RÁPIDO: A função de congelamento rápido reduz a temperatura do compartimento quando ativado algumas horas antes do uso.
	Modo de economia de energia: O modo de economia de energia permite-lhe desativar a geladeira e manter o congelador a funcionar.		Iluminação interior LED: é uma forma mais eficiente em termos energéticos e duradoura de iluminar o interior do aparelho.
	Life Plus 0°C: A temperatura nos compartimentos Lifeplus é mantida a 0°C, o que preserva a carne fresca e o peixe por mais tempo.		Tecnologia do inversor: A evolução dos secadores Smeg para modelos mais inteligentes e ambientalmente sustentáveis levou à escolha do uso da tecnologia do inversor com bombas de calor, o que reduz significativamente o consumo de energia.
	Ar mais: mantém a comida mais fresca por mais tempo.		Natural Plus Blu Light: Este exclusivo sistema Natural Plus Blu Light trabalha com a natureza para aumentar o tempo de armazenamento de frutas e legumes.
	Classe de eficiência energética F		

Benefit (TT)

No-Frost system

The No Frost system prevents the formation of ice and contributes to better preservation of food in the refrigerator

Natural Plus Blue Light

The Natural plus Blue light system extends the shelf life of fruit and vegetables while preserving their organoleptic properties

Plastic multiflow system

The Multiflow system ensures even distribution of cold air inside the refrigerator

Fan

The fan contributes to an even distribution of air inside the refrigerator

Refrigerant gas R600a

Environmentally friendly R600a refrigerant gas contributes to rapid cooling with lower energy consumption

Climate class

Climatic class SN-T makes the appliance suitable for working at room temperature between 10 °C and 43 °C (50 °F ~ 109 °F)

External handle

The external handle ensures practicality and ease of use of the refrigerator

Life Plus 0°

Temperature-controlled Life Plus compartment for optimal storage of specific food categories

Refrigerator Internal lighting

Interior lighting for perfect visibility of shelves in the refrigerator compartment

Freezer internal lighting

Interior lighting for perfect visibility of the drawers in the freezer compartment

Fruit and vegetable drawer

The fruit and vegetable drawer ensures the best storage conditions for fresh food, avoiding any contamination

Inverter compressor

Inverter compressor reduces noise and vibration levels for a quiet and comfortable kitchen environment

Inverter compressor technology offers significant advantages for refrigeration systems, improving both performance and efficiency. Better temperature control ensures a more stable and constant indoor environment, preserving the freshness of food. This technology also results in reduced energy consumption, as the compressor adjusts its speed according to cooling needs.

Manual Ice Maker

Manual ice maker to manually adjust the amount of ice produced according to personal requirements

External display

External display for simple and intuitive control with quick access to information