

FQ60CA06



Product Family	Refrigerator
Installation	Free Standing
Category	4 Doors
Reference width	Higher than 80
Reference height	160 - 200
Sistema Total No - Frost	Total
Cooling type	Total sem geada - Sistema de arrefecimento duplo
Defrost	Automatic
Reversible door	No
EAN code	8017709341480



Aesthetics



Aesthetic	Colonial	Side colour	Dark grey
Colour	Anthracite	Logotipo	Logotipo aplicado
Design	Flat	Cor do perfil das prateleiras da porta	Silver
Material	Metal sheet	Cor do perfil das gavetas	Silver
Handle kit to be ordered separately	Yes	Cor do perfil da prateleira de vidro	Chrome
Handle	Not included	Display	LED
Handle type	Fixed	Mostrar porções	Interno (no Topo)
Handle colour	Antique brass	Dispenser	No
Logo colour	Antique brass	HomeBar	No
Side material	Steel		

Refrigerator compartment features



No. of adjustable shelves	2	Bottle shelf	No
Number of fruit and vegetables drawers	2	Type of crisper/vegetable drawers cover	Glass
Type of adjustable shelves	Glass	Life Plus zone-0°C	Yes
Type of crisper/vegetable drawers cover	Standard	Internal light in fridge	Yes
Crisper Cover	Yes	Type of internal light (fridge)	LED

Refrigerator Inner Door

No. of door shelves with transparent cover	2	No. of bottle shelves	2
Number of adjustable door shelves	2	Bottle shelves with wire support	No
Adjustable door shelves with wire support	No		

Other Refrigerator features



Accessories	Egg tray	Fan	Yes
Natural Plus Blu Light	Yes	Ionizer	No
MultiFlow	Yes	Filtro de odor antibacteriano	No

Freezer compartment features

Number of drawers	4	Internal light in freezer	No
No. of shelves	2	Type of shelves	Glass

Other Freezer features



Manual ice maker	No	Fast freezing compartment	Yes
Ice maker	No	Ice tray shelf	No

Other technical features

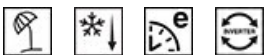

Functions display	Holiday, Fast freezing, Fast cooling, ECO
MultiZone	No
Fast freezing button	Yes
Ligaçao à rede de água	No
Door open alarm	Yes
Antibacterial Gasket	No
Type of temperature control	Electronic
No. of compressors	1
Refrigerant gas type	R600a
Type of compressor	Inverter
Refrigerant Quantity (gr)	62 g
Espuma expansiva de isolamento	Ciclopentano

Etiqueta de Desempenho / Energia - Reg. 2019

E			
Consumo de energia anual	338 kWh/a	Airborne acoustical noise emissions	37 dB(A) re 1 pW
Classe de eficiência energética	E	Autonomia de conservação sem energia elétrica	10 h
Classe de emissão de ruído acústico aerotransportado	C	4 estrelas - Capacidade de congelamento	9 Kg/24h
Volume líquido total	572 l	4 estrelas - Capacidade de congelamento 1	-18 Kg/24h
Soma dos volumes do(s) compartimento(s) congelado(s)	196 l	Classe climática	SN, N, ST, T
Soma dos volumes do(s) compartimento(s) refrigerado(s) e do(s) compartimento(s) não congelado(s)	376 l	EI	100 %

Electrical Connection

Plug	(F;E) Schuko	Voltage (V)	220-240 V
Electrical connection rating	200 W	Frequency (Hz)	50 Hz
Current	1,2 A	Power supply cable length	240 cm

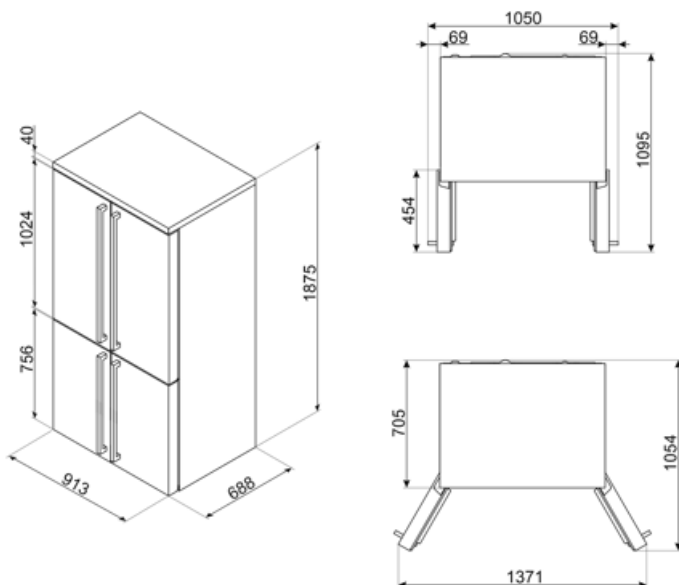

Compatible Accessories













KMOFQ7-1



KMOFQ8-1



Symbols glossary

-  Compartimento de congelamento de 4 estrelas para uma melhor preservação dos alimentos.
-  Classe de eficiência energética E.
-  Modo económico: Analisa o funcionamento da geladeira durante a ativação e otimiza o ciclo de funcionamento, a fim de reduzir o consumo de energia.
-  CONGELAMENTO RÁPIDO: A função de congelamento rápido reduz a temperatura do compartimento quando ativado algumas horas antes do uso.
-  Iluminação interior LED: é uma forma mais eficiente em termos energéticos e duradoura de iluminar o interior do aparelho.
-  Tecnologia do inversor: A evolução dos secadores Smeg para modelos mais inteligentes e ambientalmente sustentáveis levou à escolha do uso da tecnologia do inversor com bombas de calor, o que reduz significativamente o consumo de energia.
-  Natural Plus Blu Light: Este exclusivo sistema Natural Plus Blu Light trabalha com a natureza para aumentar o tempo de armazenamento de frutas e legumes.
-  O sistema de descongelamento automático funciona descongelando automaticamente em intervalos regulares, eliminando a necessidade de descongelar completamente.
-  Display LED: para mostrar os programas, funções e opções selecionadas e o tempo até ao final do ciclo.
-  Ventilado: Distribuição forçada de ar frio no compartimento da geladeira, o que permite uma distribuição uniforme da temperatura dentro da geladeira.
-  Modo de economia de energia: O modo de economia de energia permite-lhe desativar a geladeira e manter o congelador a funcionar.
-  Life Plus 0°C: A temperatura nos compartimentos Lifeplus é mantida a 0°C, o que preserva a carne fresca e o peixe por mais tempo.
-  Ar mais: mantém a comida mais fresca por mais tempo.

Benefit (TT)

No-Frost system

The No Frost system prevents the formation of ice and contributes to better preservation of food in the refrigerator

Natural Plus Blue Light

The Natural plus Blue light system extends the shelf life of fruit and vegetables while preserving their organoleptic properties

Plastic multiflow system

The Multiflow system ensures even distribution of cold air inside the refrigerator

Fan

The fan contributes to an even distribution of air inside the refrigerator

Refrigerant gas R600a

Environmentally friendly R600a refrigerant gas contributes to rapid cooling with lower energy consumption

Climate class

Climatic class SN-T makes the appliance suitable for working at room temperature between 10 °C and 43 °C (50 °F ~ 109 °F)

Life Plus 0°

Temperature-controlled Life Plus compartment for optimal storage of specific food categories

Refrigerator Internal lighting

Interior lighting for perfect visibility of shelves in the refrigerator compartment

Fruit and vegetable drawer

The fruit and vegetable drawer ensures the best storage conditions for fresh food, avoiding any contamination

Inverter compressor

Inverter compressor reduces noise and vibration levels for a quiet and comfortable kitchen environment

Inverter compressor technology offers significant advantages for refrigeration systems, improving both performance and efficiency. Better temperature control ensures a more stable and constant indoor environment, preserving the freshness of food. This technology also results in reduced energy consumption, as the compressor adjusts its speed according to cooling needs.

Internal display

Internal display for targeted temperature control and a clean, minimalist design