

# FQ60CPO6



<b>Product Family</b>	Refrigerator
<b>Installation</b>	Free standing
<b>Category</b>	4 Doors
<b>Reference width</b>	Higher than 80 cm
<b>Reference height</b>	160 - 200 cm
<b>Sistema Total No - Frost</b>	Yes
<b>Cooling type</b>	Total No Frost - Double Cooling system
<b>Defrost</b>	Automatic
<b>Handle kit to be ordered separately</b>	Yes
<b>EAN code</b>	8017709341497



## Aesthetics



<b>Aesthetic</b>	Coloniale	<b>Side colour</b>	Cream
<b>Colour</b>	Cream	<b>Logo</b>	Applied
<b>Design</b>	Flat	<b>Door shelves profile color</b>	Silver
<b>Material</b>	Metal sheet	<b>Drawers profile color</b>	Silver
<b>Handle</b>	Not included	<b>Color of glass shelf profile</b>	Chrome
<b>Handle type</b>	Fixed	<b>Display</b>	LED
<b>Handle colour</b>	Antique brass	<b>Display position</b>	Interno (sul Top)
<b>Logo colour</b>	Antique brass	<b>Alternative colours available</b>	Anthracite
<b>Side material</b>	Steel		

## Refrigerator compartment features



<b>Number of compartments</b>	3	<b>Crisper Cover</b>	Yes
<b>Compartment types</b>	Low temperature compartment, Fruit and vegetable compartment	<b>Type of crisper/vegetable drawers cover</b>	Glass
<b>No. of adjustable shelves</b>	2	<b>Low temperature compartment</b>	Yes
<b>Number of fruit and vegetables drawers</b>	2	<b>Internal light in fridge</b>	Yes
<b>Shelves material</b>	Glass	<b>Type of internal light (fridge)</b>	LED

Type of crisper/vegetable drawers cover Standard

## Refrigerator Inner Door

No. of door shelves with transparent cover 2  
 No. of bottle shelves 2  
 Number of adjustable door shelves 2

## Other Refrigerator features



Humidity Control Yes, manual  
 Accessories Egg tray  
 Natural Plus Blu Light Yes  
 MultiFlow Fan Yes

## Freezer compartment features

Number of drawers 4  
 No. of shelves 2  
 Type of shelves Glass

## Other Freezer features



Fast freezing compartment Yes

## Other technical features



Functions display Holiday, Fast freezing, Fast cooling, ECO  
 Fast freezing button Yes  
 Door open alarm Yes  
 Type of temperature control Electronic  
 No. of compressors 1  
 Refrigerant gas type R600a  
 Type of compressor Inverter  
 Refrigerant Quantity (g) 62 g  
 Foam agent Cyclopentane

## Performance / Energy Label - Reg. 2019



<b>Annual energy consumption</b>	338 kWh/a	<b>Airborne acoustical noise emissions</b>	37 dB(A) re 1 pW
<b>Energy efficiency class</b>	E	<b>Temperature Rise Time</b>	10 h
<b>Airborne acoustical noise emission class</b>	C	<b>4 star - Freezing capacity</b>	9 kg/24h
<b>Total net volume</b>	572 l	<b>Freezer (4-star) (1) - Freezing capacity</b>	-18 kg/24h
<b>Sum of the volumes of the frozen compartment(s)</b>	196 l	<b>Climate class</b>	SN, N, ST, T
<b>Sum of the volumes of the chill compartment(s) and the unfrozen compartment(s)</b>	376 l	<b>EI</b>	100 %

## Electrical Connection

<b>Electrical connection rating</b>	200 W	<b>Frequency (Hz)</b>	50 Hz
<b>Current</b>	1.2 A	<b>Power supply cable length</b>	190 cm
<b>Voltage (V)</b>	220-240 V	<b>Plug</b>	(F;E) Schuko

## Logistic Information

<b>Width</b>	915 mm	<b>Product width with maximum doors opening</b>	1370 mm
<b>Depth without handle</b>	705 mm	<b>Product depth with handle</b>	740 mm
<b>Height</b>	1870 mm	<b>Product depth with doors open at 90°</b>	1095 mm

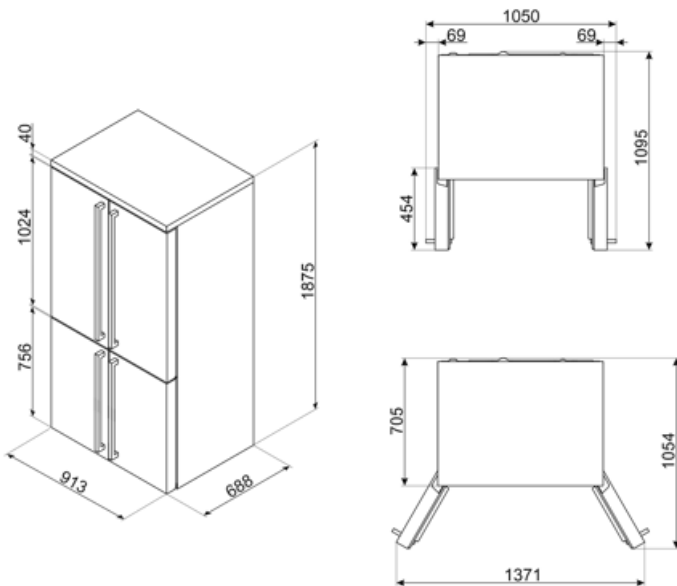

---

## Compatible Accessories

---

**KMOFQ7-1**

Set of 4 brass handles, Cortina



**KMOFQ8-1**



---

## Alternative products













---



**FQ60CA06**

Anthracite

## Symbols glossary

	4 stars freezing compartment for better food preservation.		The automatic defrost system works by automatically defrosting at regular intervals eliminating the need to defrost altogether.
	Energy efficiency class E		LED display: to show programmes, functions and options selected and the time to the end of the cycle.
	Economical mode: Analyzes fridge functioning during the activation and optimizes the operating cycle in order to reduce power consumption.		Ventilated: Forced distribution of cold air in the refrigerator compartment, which allows even temperature distribution within the fridge.
	Fast freezing: The fast freezing function brings the temperature of the compartment down when activated a few hours prior to usage.		Power saving mode: The power saving mode allows you to disable the refrigerator and keep the freezer working.
	LED interior lighting: is a more energy efficient and long lasting way of illuminating the interior of the appliance.		Smeg's evolution towards more intelligent and eco-friendly models has led to the choice of Inverter technology, which significantly reduces consumption.
	Multiflow Cooling System: the Multiflow ventilation system allows an even distribution of cool air around the fridge cabinet.		Natural Plus Blu Light: This unique Natural Plus Blu Light system works with nature to increase the storage time of fruit and vegetables.