

FQ60NDE



Product Family	Refrigerator
Installation	Free standing
Category	4 Doors
Reference width	Higher than 80 cm
Reference height	160 - 200 cm
Sistema Total No - Frost	Yes
Cooling type	Total No Frost - Double Cooling system
Defrost	Automatic
Hinge type	Standard
EAN code	8017709337674



Aesthetics



Aesthetic	Universale	Side colour	Black
Colour	Black	Logo	Applied
Design	Flat	Door shelves profile color	Silver
Material	Metal sheet	Drawers profile color	Silver
Handle	External	Color of glass shelf profile	Silver
Handle type	Fixed	Display	LED
Handle colour	Black	Display position	Esterno (su porta)
Logo colour	Chrome	Alternative colours available	Stainless steel, White
Side material	Plastic		

Refrigerator compartment features



Number of compartments	3	Crisper Cover	Yes
Compartment types	Low temperature compartment, Fruit and vegetable compartment	Type of crisper/vegetable drawers cover	Glass
No. of adjustable shelves	2	No. of lights refrigerator compartment	2
Number of fruit and vegetables drawers	2	Low temperature compartment	Yes
Shelves material	Glass	Internal light in fridge	Yes
		Type of internal light (fridge)	LED

Type of crisper/vegetable drawers cover On sliding rails

Refrigerator Inner Door

No. of door shelves with transparent cover	2	No. of bottle shelves	2
Number of adjustable door shelves	2		

Other Refrigerator features



Humidity Control	Yes, manual	MultiFlow	Yes
Accessories	Egg tray	Fan	Yes
Natural Plus Blu Light	Yes		

Freezer compartment features

Number of drawers	4	Type of shelves	Glass
No. of shelves	2		

Other Freezer features



Accessories	2 ice boxes	Fast freezing compartment	Yes
-------------	-------------	---------------------------	-----

Other technical features

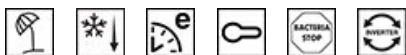

Functions display	Holiday, Fast freezing, Fast cooling, ECO, Control lock
Fast freezing button	Yes
Temperature alarm lamp	Yes
Door open alarm	Yes
Temperature Alarm	Yes
Antibacterial Gasket	Yes
Type of temperature control	Electronic
No. of compressors	1
Refrigerant gas type	R600a
Type of compressor	Inverter
Refrigerant Quantity (g)	62 g
Foam agent	Cyclopentane

Performance / Energy Label - Reg. 2019

	Annual energy consumption	338 kWh/a	Airborne acoustical noise emissions	37 dB(A) re 1 pW
	Energy efficiency class	E	Temperature Rise Time	10 h
	Airborne acoustical noise emission class	C	4 star - Freezing capacity	4,6 kg/24h
	Total net volume	572 l	Freezer (4-star) (1) - Freezing capacity	4,6 kg/24h
	Sum of the volumes of the frozen compartment(s)	196 l	Climate class	SN, N, ST, T
	Sum of the volumes of the chill compartment(s) and the unfrozen compartment(s)	376 l	EI	100 %

Electrical Connection

Electrical connection rating	200 W	Frequency (Hz)	50 Hz
Current	0,8 A	Power supply cable length	240 cm
Voltage (V)	220-240 V	Plug	(F;E) Schuko

Logistic Information

Width	908 mm	Height	1820 mm
Depth without handle	750 mm	Product width with maximum doors opening	1634 mm

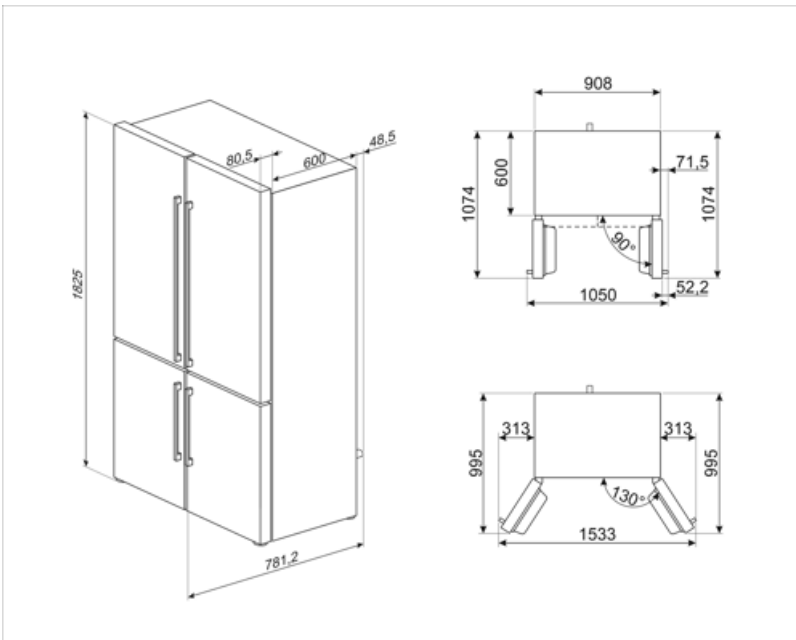













Alternative products



FQ60BDE

White

Symbols glossary

	<p>The automatic defrost system works by automatically defrosting at regular intervals eliminating the need to defrost altogether.</p>		<p>Antibacterial treatment: antibacterial treatment to ensure better hygiene.</p>
	<p>Child lock: some models are fitted with a device to lock the programme/cycle so it cannot be accidentally changed.</p>		<p>LED display: to show programmes, functions and options selected and the time to the end of the cycle.</p>
	<p>Economical mode: Analyzes fridge functioning during the activation and optimizes the operating cycle in order to reduce power consumption.</p>		<p>Ventilated: Forced distribution of cold air in the refrigerator compartment, which allows even temperature distribution within the fridge.</p>
	<p>Fast freezing: The fast freezing function brings the temperature of the compartment down when activated a few hours prior to usage.</p>		<p>Power saving mode: The power saving mode allows you to disable the refrigerator and keep the freezer working.</p>
	<p>LED interior lighting: is a more energy efficient and long lasting way of illuminating the interior of the appliance.</p>		<p>Smeg's evolution towards more intelligent and eco-friendly models has led to the choice of Inverter technology, which significantly reduces consumption.</p>
	<p>Multiflow Cooling System: the Multiflow ventilation system allows an even distribution of cool air around the fridge cabinet.</p>		<p>Natural Plus Blu Light: This unique Natural Plus Blu Light system works with nature to increase the storage time of fruit and vegetables.</p>
	<p>Energy efficiency class E</p>		