

## FQ60NDE



Product familie	Koelkast
Installatie	Vrijstaand
Categorie	Koel-vriescombinatie met 4 deuren
Referentie breedte	Meer dan 80 cm cm
Referentie hoogte	160 - 200 cm cm
No Frost systeem	Ja
Type koelen	Dubbel koelsysteem
Ontdooien	Automatisch ontdooien
Type scharnier	Standaard
EAN-code	8017709337674



## Design



Design	Universeel	Kleur zijkanten	Zwart
Kleur	Zwart	Logo	Geassembleerd
Design	Plat	Kleur profielen binnenzijde	Zilver
Materiaal deur	Plaatstaal	Kleur profielen laden	Zilver
Handgreep	Extern	Kleur profiel glazen leggers	Zilver
Type handgreep	Vast	Display	LED
Kleur handgreep	Zwart	Positie display	Esterno (su porta)
Kleur logo	Chroom	Beschikbare kleuren	Inox, Wit
Materiaal zijwanden	Kunststof		

## Uitrusting koelkast



Number of compartments	3	Afdekplaat groentenlade	Ja
Compartment types	Low temperature compartment, Fruit and vegetable compartment	Type afdekplaat groente-/fruitlade	Glas
Aantal verstelbare leggers	2	Aantal lampen	2
Aantal groente-/fruitlades	2	Low temperature compartment	Ja
Shelves material	Glas	Binnenverlichting koelkast	Ja
Type afdekplaat groente-/fruitlade	Op telescopische geleiders	Type binnenverlichting koelkast	LED

## Binnendeur koelkast

Aantal binnendeurcompartimenten met transparante deksel	2	Aantal flessenhouders	2
Aantal verstelbare binnendeurcompartimenten	2		

## Overige features koelkast



Humidity Control	Yes, manual	MultiFlow Ventilator	Ja
Accessoires	Eierhouder		
Natural Plus Blue Light	Ja		

## Uitrusting vriezer

Aantal lades	4	Type leggers	Glas
Aantal legplanken	2		

## Overige features vriezer



Accessoires	2 ijsblokjeshouders	Snel-vriescompartment	Ja
-------------	---------------------	-----------------------	----

## Overige technische eigenschappen



Display functies	Vakantiefunctie, Snel-vriesfunctie, Snel-koelfunctie, ECO, Kinderbeveiliging
Snel-vriestoets	Ja
Indicator (lampje) temperatuuralarm	Ja
Alarm open deur	Ja
Temperature Alarm	Ja
Anti bacteriële pakking	Ja
Type temperatuurcontrole	Elektronisch
Aantal compressoren	1
Type koelgas	R600a
Type compressor	Variabele toeren
Hoeveelheid koelmiddel	62 g
Schuimmiddel	Cyclopentaan

## Prestaties/Energie label - Reg. 2019

<b>Annual energy consumption</b>	338 kWh/jaar	<b>Geluidsniveau</b>	37 dB(A) re 1 pW
<b>Energie-efficiëntieklasse</b>	E	<b>Conserveringsduur zonder stroom</b>	10 h
<b>Emissieklasse voor akoestisch luchtgeluid</b>	C	<b>4 star - Freezing capacity</b>	4,6 kg/24h
<b>Totaal netto volume</b>	572 l	<b>Freezer (4-star) (1) - Freezing capacity</b>	4,6 kg/24h
<b>Netto inhoud vriesgedeelte</b>	196 l	<b>Klimaatklasse</b>	SN, N, ST, T
<b>Netto inhoud koelgedeeltes</b>	376 l	<b>EEl</b>	100 %

## Elektrische aansluiting

<b>Nominale aansluitwaarde</b>	200 W	<b>Frequentie (Hz)</b>	50 Hz
<b>Stroom (A)</b>	0,8 A	<b>Lengte stroomkabel</b>	240 cm
<b>Spanning (V)</b>	220-240 V	<b>Stekker</b>	(F;E) Schuko

## Logistieke informatie

<b>Breedte product (mm)</b>	908 mm	<b>Maximum hoogte</b>	1820 mm
<b>Diepte zonder handvat en spacer</b>	750 mm	<b>Product breedte met maximale deuropening</b>	1634 mm

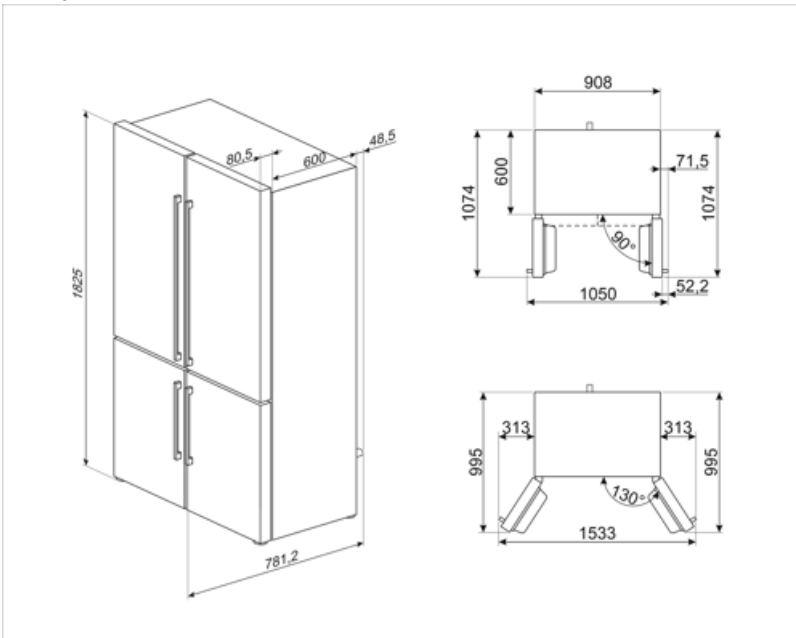

---

## Alternative products













---



**FQ60BDE**

Wit

## Symbols glossary

	The automatic defrost system works by automatically defrosting at regular intervals eliminating the need to defrost altogether.		Antibacterial treatment: antibacterial treatment to ensure better hygiene.
	Sommige modellen zijn voorzien van een functie om het programma/de cyclus te blokkeren zodat het niet per ongeluk kan aangepast worden.		LED display: to show programmes, functions and options selected and the time to the end of the cycle.
	Economical mode: Analyzes fridge functioning during the activation and optimizes the operating cycle in order to reduce power consumption.		Geventileerd: een geforceerde verdeling van koude lucht in het koelkast compartiment, die een gelijke temperatuurverdeling verzekert in de koelkast.
	Fast freezing: The fast freezing function brings the temperature of the compartment down when activated a few hours prior to usage.		Power saving mode: The power saving mode allows you to disable the refrigerator and keep the freezer working.
	LED interior lighting: is a more energy efficient and long lasting way of illuminating the interior of the appliance.		De evolutie van Smeg vaatwassers naar meer intelligente en milieuvriendelijke modellen heeft ertoe geleid om de inverter technologie te gebruiken, die een significante energie- en geluidsbesparing met zich meebrengt.
	Multiflow Cooling System: the Multiflow ventilation system allows an even distribution of cool air around the fridge cabinet.		Natural Plus Blue Light: Dit unieke Natural Plus Blue Light-systeem verlengt de bewaartijd van groenten en fruit
	Energie-efficiëntieklasse		