

# FQ60NPE

Product Family	Refrigerator
Installation	Free standing
Category	4 Doors
Sistema Total No - Frost	Total
Cooling type	Total No Frost - Triple Cooling system
Hinge type	Standard
EAN code	8017709177430



## Aesthetics

			
Aesthetic	Universale	Side material	Steel
Colour	Black	Side colour	Black
Design	Flat	Logo	Applied
Material	Metal sheet	Display	LCD Touch
Handle	External	Display position	
Handle type	Fixed	Alternative colours available	Stainless steel, White
Handle colour	Black	Available colours	FQ60XPE, FQ60BPE
Logo colour	Chrome		

## Refrigerator compartment features

			
Shelves material	Glass	Life Plus zone-0°C	Yes
Crisper Cover	Yes	Internal light in fridge	Yes
Bottle shelf	Yes	Type of internal light (fridge)	LED
Type of crisper/vegetable drawers cover	Glass		

## Refrigerator Inner Door

No. of door shelves with transparent cover	2	Bottle shelves with wire support	Yes
No. of bottle shelves	2		

## Other Refrigerator features



Accessories	2 sliders, Egg tray	Fan	Yes
Natural Plus Blu Light	Yes	Ionizer	Yes
MultiFlow	Yes	Antibacterial odour filter	Yes

## Freezer compartment features

Number of drawers	5	Type of shelves	Plastic
-------------------	---	-----------------	---------

## Other Freezer features



Fast freezing compartment	Yes
---------------------------	-----

## Other technical features



Functions display	Holiday, Fast freezing, Fast cooling, MultiZone, ECO, Control lock
MultiZone	Yes
Fast freezing button	Yes
Water network connection	
Temperature alarm lamp	Yes
Door open alarm	Yes
Temperature Alarm	Yes
Antibacterial Gasket	Yes
Type of temperature control	Electronic
No. of compressors	1
Refrigerant gas type	R600a
Refrigerant Quantity (g)	68 g
Foam agent	Cyclopentane

## Performance / Energy Label - Reg. 2019

Airborne acoustical noise emissions	46 dB(A) re 1 pW
-------------------------------------	------------------

## Electrical Connection







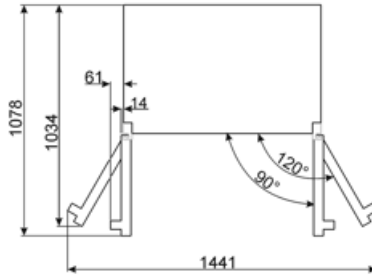
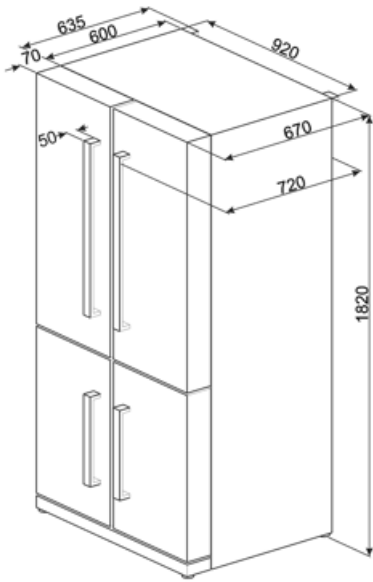







<b>Electrical connection rating</b>	200 W	<b>Frequency (Hz)</b>	50 Hz
<b>Current</b>	0.95 A	<b>Power supply cable length</b>	215 cm
<b>Voltage (V)</b>	220-240 V	<b>Plug</b>	(F;E) Schuko

## Logistic Information

<b>Width</b>	920 mm	<b>Product depth with handle</b>	720 mm
<b>Depth without handle</b>	720 mm	<b>Product depth with doors open at 90°</b>	1078 mm
<b>Height</b>	1820 mm	<b>Spacer depth</b>	35 mm
<b>Product width with maximum doors opening</b>	1656 mm		



## Symbols glossary

 <p>4 stars freezing compartment for better food preservation.</p>	 <p>Smeg Active Ion system improves the quality of the air inside the cell. Thanks to the generation of negatively charged ions released inside the fridge Active Ion system neutralizes unpleasant dust.</p>
 <p>Antibacterial treatment: antibacterial treatment to ensure better hygiene.</p>	 <p>Child lock: some models are fitted with a device to lock the programme/cycle so it cannot be accidentally changed.</p>
 <p>A+: Energy efficiency class A+ helps to save up to 10% energy compared to class A. Maximum performance with minimum consumption is guaranteed.</p>	 <p>LCD display: to optimize performance and simplify the use of the appliance.</p>
 <p>Economical mode: Analyzes fridge functioning during the activation and optimizes the operating cycle in order to reduce power consumption.</p>	 <p>Ventilated: Forced distribution of cold air in the refrigerator compartment, which allows even temperature distribution within the fridge.</p>
 <p>Fast freezing: The fast freezing function brings the temperature of the compartment down when activated a few hours prior to usage.</p>	 <p>Power saving mode: The power saving mode allows you to disable the refrigerator and keep the freezer working.</p>
 <p>LED interior lighting: is a more energy efficient and long lasting way of illuminating the interior of the appliance.</p>	 <p>Life Plus 0°C: The temperature in the Lifeplus compartments is kept at 0°C, which preserves fresh meat and fish longer.</p>
 <p>Multiflow Cooling System: the Multiflow ventilation system allows an even distribution of cool air around the fridge cabinet.</p>	 <p>Multizone: Multizone compartment can be used as a refrigerator or a freezer compartment. Depending on your needs and eating habits, you can select settings, program the temperature using.</p>
 <p>Natural Plus Blu Light: This unique Natural Plus Blu Light system works with nature to increase the storage time of fruit and vegetables.</p>	