

FQ60XDAIE



| | |
|--------------------|-----------------------------------|
| Product familie | Koelkast |
| Installatie | Vrijstaand |
| Categorie | Koel-vriescombinatie met 4 deuren |
| Referentie breedte | Meer dan 80 cm cm |
| Referentie hoogte | 160 - 200 cm cm |
| No Frost systeem | Ja |
| Type koelen | Drievoudig koelsysteem |
| Ontdooien | Automatisch ontdooien |
| Type scharnier | Standaard |
| EAN-code | 8017709337704 |



Design



| | | | |
|-----------------|----------------|------------------------------|--------------------|
| Design | Universeel | Kleur logo | Chroom |
| Kleur | Inox Look | Materiaal zijwanden | Staal |
| Design | Plat | Kleur zijkanten | Zilver |
| Afwerking | Fingerproof | Logo | Geassembleerd |
| Materiaal deur | Inox look | Kleur profielen binnenzijde | Zilver |
| Type inox | Vingervlekvrij | Kleur profielen laden | Zilver |
| Handgreep | Extern | Kleur profiel glazen leggers | Zilver |
| Type handgreep | Vast | Display | LED |
| Kleur handgreep | Inox | Positie display | Esterno (su porta) |

Uitrusting koelkast



| | | | |
|----------------------------|--|---|------|
| Number of compartments | 3 | Afdekplaat groentenlade | Ja |
| Compartment types | Low temperature compartment, Fruit and vegetable compartment | Type afdekplaat groente-/fruitlade | Glas |
| Aantal verstelbare leggers | 2 | Aantal lampen Low temperature compartment | 2 |
| Aantal groente-/fruitlades | 2 | Binnenverlichting koelkast | Ja |
| Shelves material | Glas | Type binnenverlichting koelkast | LED |

Type afdekplaat groente-/fruitlade Op telescopische geleiders

Binnendeur koelkast

| | | | |
|---|---|-----------------------|---|
| Aantal binnendeurcompartimenten met transparante deksel | 2 | Aantal flessenhouders | 2 |
| Aantal verstelbare binnendeurcompartimenten | 2 | | |

Overige features koelkast



| | | | |
|-------------------------|-------------|------------|----|
| Humidity Control | Yes, manual | MultiFlow | Ja |
| Accessoires | Eierhouder | Ventilator | Ja |
| Natural Plus Blue Light | Ja | | |

Uitrusting vriezer

| | | | |
|-------------------|---|---------------------------|------|
| Aantal lades | 4 | Binnenverlichting vriezer | Ja |
| Aantal legplanken | 2 | Type verlichting vriezer | LED |
| Aantal lampen | 2 | Type leggers | Glas |

Overige features vriezer



| | | | |
|----------------------|--------|------------------------|-------|
| Ice maker | Ja | Ice shape | Cubes |
| Daily ice production | 2,0 kg | Snel-vriescompartiment | Ja |

Overige technische eigenschappen

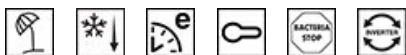

| | |
|-------------------------------------|--|
| Display functies | Vakantiefunctie, Snel-vriesfunctie, Snel-koelfunctie, ECO, Kinderbeveiliging |
| Snel-vriestoets | Ja |
| Indicator (lampje) temperatuuralarm | Ja |
| Alarm open deur | Akoestisch en visueel |
| Temperature Alarm | Akoestisch en visueel |
| Anti bacteriële pakking | Ja |
| Type temperatuurcontrole | Elektronisch |
| Aantal compressoren | 1 |
| Type koelgas | R600a |
| Type compressor | Variabele toeren |
| Schuimmiddel | Cyclopentaan |

Prestaties/Energie label - Reg. 2019

| | | | |
|--|--------------|--|------------------|
|  | | | |
| Annual energy consumption | 338 kWh/jaar | Geluidsniveau | 37 dB(A) re 1 pW |
| Energie-efficiëntieklasse | E | Conserveringsduur zonder stroom | 10 h |
| Emissieklasse voor akoestisch luchtgeluid | C | 4 star - Freezing capacity | 4,6 kg/24h |
| Totaal netto volume | 572 l | Freezer (4-star) (1) - Freezing capacity | 4,6 kg/24h |
| Netto inhoud vriesgedeelte | 196 l | Klimaatklasse | SN, N, ST, T |
| Netto inhoud koelgedeeltes | 376 l | EEl | 100 % |

Elektrische aansluiting







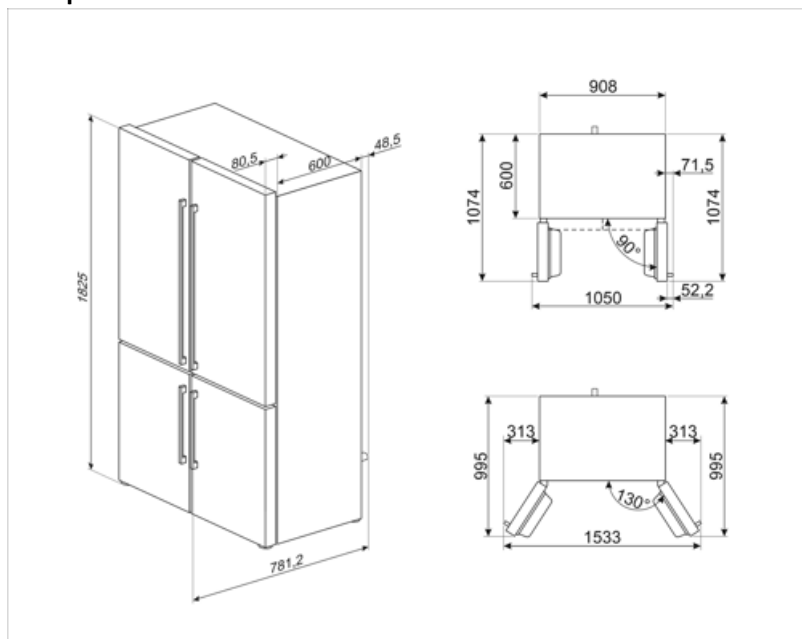







| | | | |
|-------------------------|-----------|--------------------|--------------|
| Nominale aansluitwaarde | 200 W | Frequentie (Hz) | 50 Hz |
| Stroom (A) | 0,8 A | Lengte stroomkabel | 240 cm |
| Spanning (V) | 220-240 V | Stekker | (F;E) Schuko |

Logistieke informatie

| | | | |
|---------------------------------|--------|--|---------|
| Breedte product (mm) | 908 mm | Maximum hoogte | 1820 mm |
| Diepte zonder handvat en spacer | 750 mm | Product breedte met maximale deuropening | 1634 mm |



Symbols glossary

| | | | |
|--|--|---|--|
|  | The automatic defrost system works by automatically defrosting at regular intervals eliminating the need to defrost altogether. |  | Antibacterial treatment: antibacterial treatment to ensure better hygiene. |
|  | Sommige modellen zijn voorzien van een functie om het programma/de cyclus te blokkeren zodat het niet per ongeluk kan aangepast worden. |  | Energie-efficiëntieklasse |
|  | LED display: to show programmes, functions and options selected and the time to the end of the cycle. |  | Economical mode: Analyzes fridge functioning during the activation and optimizes the operating cycle in order to reduce power consumption. |
|  | Geventileerd: een geforceerde verdeling van koude lucht in het koelkast compartiment, die een gelijke temperatuurverdeling verzekert in de koelkast. |  | Fast freezing: The fast freezing function brings the temperature of the compartment down when activated a few hours prior to usage. |
|  | Fingerprint proof stainless steel: Fingerprint proof stainless steel keeps stainless steel looking as good as new. |  | Power saving mode: The power saving mode allows you to disable the refrigerator and keep the freezer working. |
|  | LED interior lighting: is a more energy efficient and long lasting way of illuminating the interior of the appliance. |  | De evolutie van Smeg vaatwassers naar meer intelligente en milieuvriendelijke modellen heeft ertoe geleid om de inverter technologie te gebruiken, die een significante energie- en geluidsbesparing met zich meebrengt. |
|  | Multiflow Cooling System: the Multiflow ventilation system allows an even distribution of cool air around the fridge cabinet. |  | Natural Plus Blue Light: Dit unieke Natural Plus Blue Light-systeem verlengt de bewaartijd van groenten en fruit |