

FQ60XDAIE



Product Family	Refrigerator
Installation	Free Standing
Category	4 Doors
Reference width	Higher than 80
Reference height	160 - 200
Sistema Total No - Frost	Total
Cooling type	Total sem geada - sistema de arrefecimento triplo
Defrost	Automatic
Hinge type	Standard
EAN code	8017709337704



Aesthetics



Aesthetic	Universal	Side material	Steel
Colour	Aspecto inox	Side colour	Silver
Acabamento	Anti-dedadas	Logotipo	Logotipo aplicado
Design	Flat	Cor do perfil das prateleiras da porta	Silver
Material	Steel Effect	Cor do perfil das gavetas	Silver
Door steel type	Finger proof	Cor do perfil da prateleira de vidro	Silver
Handle kit to be ordered separately	No	Display	LED
Handle	External	Mostrar porções	Externo (na porta)
Handle type	Fixed	Dispenser	No
Handle colour	Stainless steel	Water Filter	No
Logo colour	Chrome	HomeBar	No

Refrigerator compartment features



No. of adjustable shelves	2	Type of crisper/vegetable drawers cover	Glass
Number of fruit and vegetables drawers	2	Nº de lâmpadas	2
Type of adjustable shelves	Glass	Life Plus zone-0°C	Yes
		Compartimento baixa temperatura	No
		Internal light in fridge	Yes

Type of crisper/vegetable drawers cover	On sliding rails	Type of internal light (fridge)	LED
Crisper Cover	Yes		
Bottle shelf	No		

Refrigerator Inner Door

No. of door shelves with transparent cover	2	No. of bottle shelves	2
Number of adjustable door shelves	2	Bottle shelves with wire support	No
Adjustable door shelves with wire support	No		

Other Refrigerator features



Accessories	Egg tray	Fan	Yes
Natural Plus Blu Light	Yes	Ionizer	No
MultiFlow	Yes	Filtro de odor antibacteriano	No

Freezer compartment features

Number of drawers	4	Internal light in freezer	Yes
No. of shelves	2	Type of internal light (freezer)	LED
Nº de lâmpadas	2	Type of shelves	Glass

Other Freezer features



Manual ice maker	No	Fast freezing compartment	Yes
Ice maker	Automatic		

Other technical features

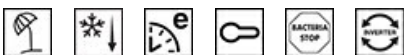

Functions display	Holiday, Fast freezing, Fast cooling, ECO, Control lock
MultiZone	No
Fast freezing button	Yes
Ligação à rede de água	No
Temperature alarm lamp	Yes
Door open alarm	Acoustic and visual
Temperature Alarm	Acoustic and visual

Antibacterial Gasket	Yes
Type of temperature control	Electronic
No. of compressors	1
Refrigerant gas type	R600a
Type of compressor	Inverter
Espuma expansiva de isolamento	Ciclopentano

Etiqueta de Desempenho / Energia - Reg. 2019







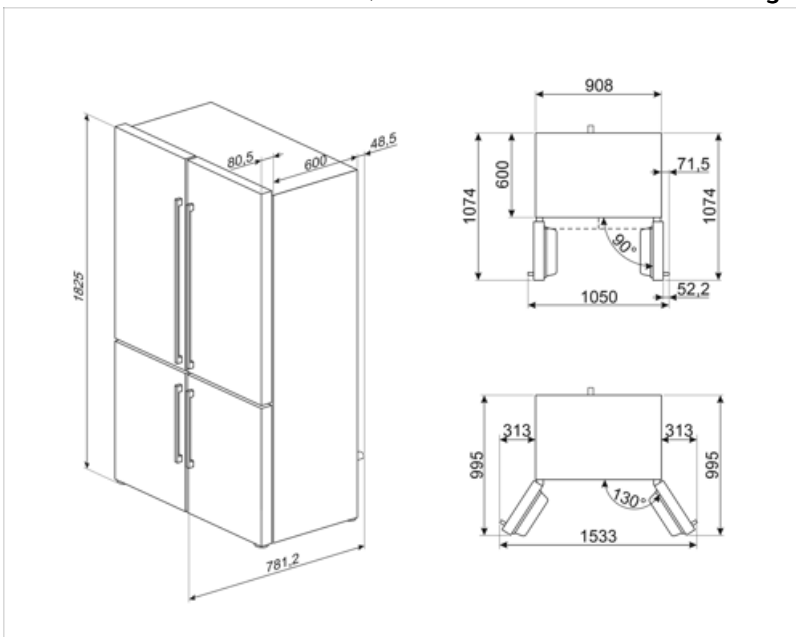







			
Consumo de energia anual	338 kWh/a	Airborne acoustical noise emissions	37 dB(A) re 1 pW
Classe de eficiência energética	E	Autonomia de conservação sem energia elétrica	10 h
Classe de emissão de ruído acústico aerotransportado	C	4 estrelas - Capacidade de congelamento	4.6 Kg/24h
Volume líquido total	572 l	4 estrelas - Capacidade de congelamento 1	4.6 Kg/24h
Soma dos volumes do(s) compartimento(s) congelado(s)	196 l	Classe climática	SN, N, ST, T
Soma dos volumes do(s) compartimento(s) refrigerado(s) e do(s) compartimento(s) não congelado(s)	376 l	EI	100 %

Electrical Connection

Plug	(F;E) Schuko	Voltage (V)	220-240 V
Electrical connection rating	200 W	Frequency (Hz)	50 Hz
Current	0,8 A	Power supply cable length	240 cm



Symbols glossary

 <p>O sistema de descongelamento automático funciona descongelando automaticamente em intervalos regulares, eliminando a necessidade de descongelar completamente.</p>	 <p>Tratamento antibacteriano: tratamento antibacteriano para garantir uma melhor higiene</p>
 <p>Bloqueio para crianças: alguns modelos estão equipados com um dispositivo para bloquear o programa/ciclo para que não possa ser acidentalmente alterado.</p>	 <p>Classe de eficiência energética E.</p>
 <p>Display LED: para mostrar os programas, funções e opções selecionadas e o tempo até ao final do ciclo.</p>	 <p>Modo económico: Analisa o funcionamento da geladeira durante a ativação e otimiza o ciclo de funcionamento, a fim de reduzir o consumo de energia.</p>
 <p>Ventilado: Distribuição forçada de ar frio no compartimento da geladeira, o que permite uma distribuição uniforme da temperatura dentro da geladeira.</p>	 <p>CONGELAMENTO RÁPIDO: A função de congelamento rápido reduz a temperatura do compartimento quando ativado algumas horas antes do uso.</p>
 <p>Aço inoxidável à prova de dedadas: O aço inoxidável à prova de dedadas mantém o aço inoxidável com um aspeto novo.</p>	 <p>Modo de economia de energia: O modo de economia de energia permite-lhe desativar a geladeira e manter o congelador a funcionar.</p>
 <p>Iluminação interior LED: é uma forma mais eficiente em termos energéticos e duradoura de iluminar o interior do aparelho.</p>	 <p>Life Plus 0°C: A temperatura nos compartimentos Lifeplus é mantida a 0°C, o que preserva a carne fresca e o peixe por mais tempo.</p>
 <p>Tecnologia do inversor: A evolução dos secadores Smeg para modelos mais inteligentes e ambientalmente sustentáveis levou à escolha do uso da tecnologia do inversor com bombas de calor, o que reduz significativamente o consumo de energia.</p>	 <p>Ar mais: mantém a comida mais fresca por mais tempo.</p>
 <p>Natural Plus Blu Light: Este exclusivo sistema Natural Plus Blu Light trabalha com a natureza para aumentar o tempo de armazenamento de frutas e legumes.</p>	

Benefit (TT)

No-Frost system

The No Frost system prevents the formation of ice and contributes to better preservation of food in the refrigerator

Natural Plus Blue Light

The Natural plus Blue light system extends the shelf life of fruit and vegetables while preserving their organoleptic properties

Plastic multiflow system

The Multiflow system ensures even distribution of cold air inside the refrigerator

Fan

The fan contributes to an even distribution of air inside the refrigerator

Refrigerant gas R600a

Environmentally friendly R600a refrigerant gas contributes to rapid cooling with lower energy consumption

External handle

The external handle ensures practicality and ease of use of the refrigerator

Life Plus 0°

Temperature-controlled Life Plus compartment for optimal storage of specific food categories

Refrigerator Internal lighting

Interior lighting for perfect visibility of shelves in the refrigerator compartment

Freezer internal lighting

Interior lighting for perfect visibility of the drawers in the freezer compartment

Fruit and vegetable drawer

The fruit and vegetable drawer ensures the best storage conditions for fresh food, avoiding any contamination

Inverter compressor

Inverter compressor reduces noise and vibration levels for a quiet and comfortable kitchen environment

Inverter compressor technology offers significant advantages for refrigeration systems, improving both performance and efficiency. Better temperature control ensures a more stable and constant indoor environment, preserving the freshness of food. This technology also results in reduced energy consumption, as the compressor adjusts its speed according to cooling needs.

Automatic Ice Maker

Automatic ice maker for ice always available when needed

The automatic ice maker is connected directly to the kitchen water supply, so there is no need to manually fill any tanks. This saves considerable time and ensures hygiene and convenience.

External display

External display for simple and intuitive control with quick access to information