

FQ60XDE



Product familie	Koelkast
Installatie	Vrijstaand
Categorie	Koel-vriescombinatie met 4 deuren
Referentie breedte	Meer dan 80 cm
Referentie hoogte	160 - 200 cm
No Frost systeem	Ja
Type koelen	Dubbel koelsysteem
Ontdooien	Automatisch ontdooien
Type scharnier	Standaard
EAN-code	8017709337698



Design



Design	Universeel	Materiaal zijwanden	Staal
Kleur	Inox Look	Kleur zijkanten	Zilver
Design	Plat	Logo	Geassembleerd
Afwerking	Fingerproof	Kleur profielen binnenzijde	Zilver
Materiaal deur	Inox look	Kleur profielen laden	Zilver
Type inox	Vingervlekvrij	Kleur profiel glazen leggers	Zilver
Handgreep	Extern	Display	LED
Type handgreep	Vast	Positie display	Esterno (su porta)
Kleur handgreep	Inox	Beschikbare kleuren	Wit, Zwart
Kleur logo	Chroom		

Uitrusting koelkast



Number of compartments	3	Type afdekplaat groente-/fruitlade	Glas
Compartment types	Low temperature compartment, Fruit and vegetable compartment	Aantal lampen	2
Aantal verstelbare leggers	2	Convertible temperature drawer	No
Aantal groente-/fruitlades	2	Low temperature compartment	Ja
Shelves material	Glas	Binnenverlichting koelkast	Ja
		Type binnenverlichting koelkast	LED

Type afdekplaat groente-/fruitlade	Op telescopische geleiders
Afdekplaat groentenlade	Ja

Binnendeur koelkast

Aantal binnendeurcompartimenten met transparante deksel	2	Aantal flessenhouders	2
Aantal verstelbare binnendeurcompartimenten	2		

Overige features koelkast



Humidity Control	Yes, manual	MultiFlow	Ja
Accessoires	Eierhouder	Ventilator	Ja
Natural Plus Blue Light	Ja	Anti bacteriële geurfilter	Ja

Uitrusting vriezer

Aantal lades	4	Type leggers	Glas
Aantal legplanken	2		

Overige features vriezer



Accessoires	2 ijsblokjeshouders	Snel-vriescompartment	Ja
-------------	---------------------	-----------------------	----

Overige technische eigenschappen

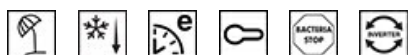

Display functies	Vakantiefunctie, Snel-vriesfunctie, Snel-koelfunctie, ECO, Kinderbeveiliging
Snel-vriestoets	Ja
Indicator (lampje) temperatuuralarm	Ja
Alarm open deur	Ja
Temperature Alarm	Ja
Anti bacteriële pakking	Ja
Type temperatuurcontrole	Elektronisch
Aantal compressoren	1
Type koelgas	R600a
Type compressor	Variabele toeren
Schuimmiddel	Cyclopentaan

Prestaties/Energie label - Reg. 2019

			
Annual energy consumption	338 kWh/jaar	Geluidsniveau	37 dB(A) re 1 pW
Energie-efficiëntieklasse	E	Conserveringsduur zonder stroom	10 h
Emissieklasse voor akoestisch luchtgeluid	C	4 star - Freezing capacity	4,6 kg/24h
Totaal netto volume	541 l	Freezer (4-star) (1) - Freezing capacity	4,6 kg/24h
Netto inhoud vriesgedeelte	165 l	Klimaatklasse	SN, N, ST, T
Netto inhoud koelgedeeltes	376 l	EEl	100 %

Elektrische aansluiting







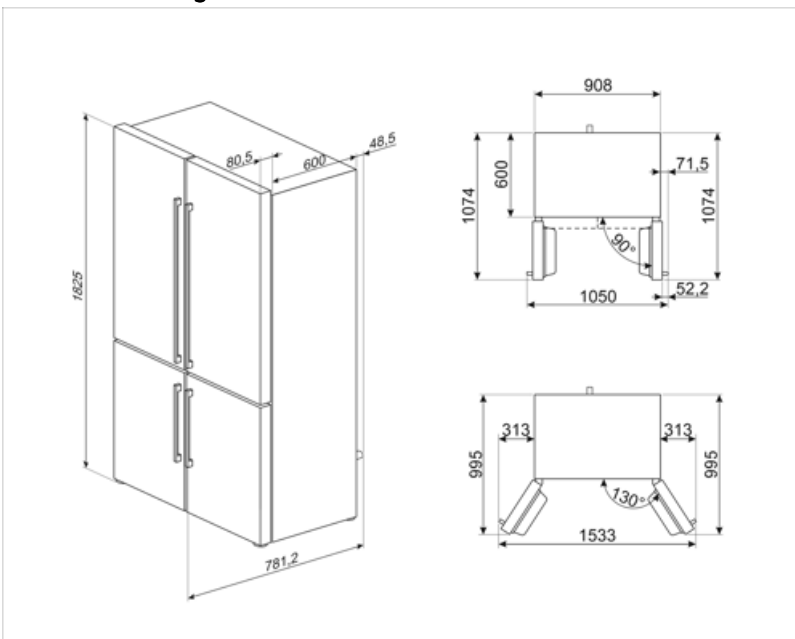







Nominale aansluitwaarde	200 W	Frequentie (Hz)	50 Hz
Stroom (A)	0,8 A	Lengte stroomkabel	240 cm
Spanning (V)	220-240 V	Stekker	(F;E) Schuko

Logistieke informatie

Breedte product (mm)	908 mm	Product breedte met maximale deuropening	1634 mm
Maximum hoogte	1820 mm		



Symbols glossary

	The automatic defrost system works by automatically defrosting at regular intervals eliminating the need to defrost altogether.		Antibacterial treatment: antibacterial treatment to ensure better hygiene.
	Sommige modellen zijn voorzien van een functie om het programma/de cyclus te blokkeren zodat het niet per ongeluk kan aangepast worden.		LED display: to show programmes, functions and options selected and the time to the end of the cycle.
	Economical mode: Analyzes fridge functioning during the activation and optimizes the operating cycle in order to reduce power consumption.		Geventileerd: een geforceerde verdeling van koude lucht in het koelkast compartiment, die een gelijke temperatuurverdeling verzekert in de koelkast.
	Fast freezing: The fast freezing function brings the temperature of the compartment down when activated a few hours prior to usage.		Fingerprint proof stainless steel: Fingerprint proof stainless steel keeps stainless steel looking as good as new.
	Power saving mode: The power saving mode allows you to disable the refrigerator and keep the freezer working.		LED interior lighting: is a more energy efficient and long lasting way of illuminating the interior of the appliance.
	De evolutie van Smeg vaatwassers naar meer intelligente en milieuvriendelijke modellen heeft ertoe geleid om de inverter technologie te gebruiken, die een significante energie- en geluidsbesparing met zich meebrengt.		Multiflow Cooling System: the Multiflow ventilation system allows an even distribution of cool air around the fridge cabinet.
	Natural Plus Blue Light: Dit unieke Natural Plus Blue Light-systeem verlengt de bewaartijd van groenten en fruit		Energie-efficiëntieklasse