

# FQ60XDF



Product Family	Refrigerator
Installation	Free Standing
Category	4 Doors
Reference width	Higher than 80
Sistema Total No - Frost	Total
Cooling type	Total sem geada - Sistema de arrefecimento duplo
Defrost	Automatic
Hinge type	Standard
EAN code	8017709293307



## Aesthetics



Aesthetic	Universal	Side colour	Silver
Colour	Aspecto inox	Logotipo	Logotipo aplicado
Acabamento	Anti-dedadas	Cor do perfil das prateleiras da porta	Silver
Design	Flat	Cor do perfil das gavetas	Silver
Material	Steel Effect	Cor do perfil da prateleira de vidro	Silver
Door steel type	Finger proof	Display	LED
Handle kit to be ordered separately	No	Mostrar porções	Externo (na porta)
Handle	External	Dispenser	No
Handle type	Fixed	Water Filter	No
Handle colour	Stainless steel	HomeBar	No
Logo colour	Chrome	Alternative colours available	White, Black
Side material	Steel		

## Refrigerator compartment features



No. of adjustable shelves	2	Type of crisper/vegetable drawers cover	Glass
Number of fruit and vegetables drawers	2	Life Plus zone-0°C	Yes
Type of adjustable shelves	Glass	Compartimento baixa temperatura	No
		Internal light in fridge	Yes

Type of crisper/vegetable drawers cover	On sliding rails	Type of internal light (fridge)	LED
Crisper Cover	Yes		
Bottle shelf	No		

## Refrigerator Inner Door

No. of door shelves with transparent cover	2	No. of bottle shelves	2
Number of adjustable door shelves	2	Bottle shelves with wire support	No
Adjustable door shelves with wire support	No		

## Other Refrigerator features



Accessories	Egg tray	Ionizer	Yes
Natural Plus Blu Light	Yes	Tecnologia de titânio	No
MultiFlow	Yes	Filtro de odor antibacteriano	Yes
Fan	Yes		

## Freezer compartment features

Number of drawers	3	Type of internal light (freezer)	LED
No. of shelves	2	Type of shelves	Glass
Internal light in freezer	Yes		

## Other Freezer features



Manual ice maker	Yes	Fast freezing compartment	Yes
Ice maker	Manual	Ice tray shelf	No

## Other technical features

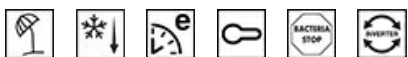

Functions display	Holiday, Fast freezing, Fast cooling, ECO, Control lock
MultiZone	No
Fast freezing button	Yes
Ligaçao à rede de água	No
Temperature alarm lamp	Yes
Door open alarm	Yes
Temperature Alarm	Yes

Antibacterial Gasket	Yes
Type of temperature control	Electronic
No. of compressors	1
Refrigerant gas type	R600a
Type of compressor	Inverter
Refrigerant Quantity (gr)	72 g
Espuma expansiva de isolamento	Ciclopentano

## Etiqueta de Desempenho / Energia - Reg. 2019







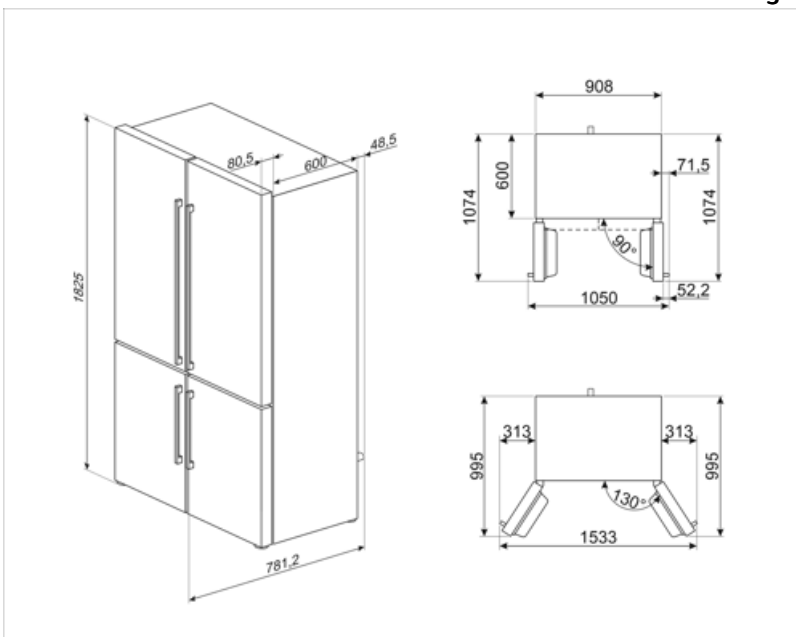



<b>F</b>			
Consumo de energia anual	406 kWh/a	Airborne acoustical noise emissions	39 dB(A) re 1 pW
Classe de eficiência energética	F	Autonomia de conservação sem energia elétrica	10 h
Classe de emissão de ruído acústico aerotransportado	C	4 estrelas - Capacidade de congelamento	4.6 Kg/24h
Volume líquido total	541 l	4 estrelas - Capacidade de congelamento 1	4.6 Kg/24h
Soma dos volumes do(s) compartimento(s) congelado(s)	165 l	Classe climática	SN, T
Soma dos volumes do(s) compartimento(s) refrigerado(s) e do(s) compartimento(s) não congelado(s)	376 l	EEl	125 %

## Electrical Connection

Plug	(F;E) Schuko	Voltage (V)	230 V
Electrical connection rating	200 W	Frequency (Hz)	50 Hz
Current	0.8 A	Power supply cable length	240 cm



## Symbols glossary

	Compartimento de congelamento de 4 estrelas para uma melhor preservação dos alimentos.		A+: A classe de eficiência energética A+ ajuda a economizar até 10% de energia em comparação com a classe A. O desempenho máximo com consumo mínimo é garantido.
	Smeg Active Ion system improves the quality of the air inside the cell. Thanks to the generation of negatively charged ions released inside the fridge Active Ion system neutralizes unpleasant dust.		O sistema de descongelamento automático funciona descongelando automaticamente em intervalos regulares, eliminando a necessidade de descongelar completamente.
	Tratamento antibacteriano: tratamento antibacteriano para garantir uma melhor higiene		Bloqueio para crianças: alguns modelos estão equipados com um dispositivo para bloquear o programa/ciclo para que não possa ser acidentalmente alterado.
	Display LED: para mostrar os programas, funções e opções selecionadas e o tempo até ao final do ciclo.		Modo económico: Analisa o funcionamento da geladeira durante a ativação e otimiza o ciclo de funcionamento, a fim de reduzir o consumo de energia.
	Ventilado: Distribuição forçada de ar frio no compartimento da geladeira, o que permite uma distribuição uniforme da temperatura dentro da geladeira.		CONGELAMENTO RÁPIDO: A função de congelamento rápido reduz a temperatura do compartimento quando ativado algumas horas antes do uso.
	Aço inoxidável à prova de dedadas: O aço inoxidável à prova de dedadas mantém o aço inoxidável com um aspeto novo.		Modo de economia de energia: O modo de economia de energia permite-lhe desativar a geladeira e manter o congelador a funcionar.
	Iluminação interior LED: é uma forma mais eficiente em termos energéticos e duradoura de iluminar o interior do aparelho.		Life Plus 0°C: A temperatura nos compartimentos Lifeplus é mantida a 0°C, o que preserva a carne fresca e o peixe por mais tempo.
	Tecnologia do inversor: A evolução dos secadores Smeg para modelos mais inteligentes e ambientalmente sustentáveis levou à escolha do uso da tecnologia do inversor com bombas de calor, o que reduz significativamente o consumo de energia.		Ar mais: mantém a comida mais fresca por mais tempo.
	Natural Plus Blu Light: Este exclusivo sistema Natural Plus Blu Light trabalha com a natureza para aumentar o tempo de armazenamento de frutas e legumes.		Classe de eficiência energética F

---

## Benefit (TT)

---

### **No-Frost system**

The No Frost system prevents the formation of ice and contributes to better preservation of food in the refrigerator

### **Natural Plus Blue Light**

The Natural plus Blue light system extends the shelf life of fruit and vegetables while preserving their organoleptic properties

### **Plastic multiflow system**

The Multiflow system ensures even distribution of cold air inside the refrigerator

### **Fan**

The fan contributes to an even distribution of air inside the refrigerator

### **Refrigerant gas R600a**

Environmentally friendly R600a refrigerant gas contributes to rapid cooling with lower energy consumption

### **Climate class**

Climatic class SN-T makes the appliance suitable for working at room temperature between 10 °C and 43 °C (50 °F ~ 109 °F)

### **External handle**

The external handle ensures practicality and ease of use of the refrigerator

### **Life Plus 0°**

Temperature-controlled Life Plus compartment for optimal storage of specific food categories

### **Refrigerator Internal lighting**

Interior lighting for perfect visibility of shelves in the refrigerator compartment

### **Freezer internal lighting**

Interior lighting for perfect visibility of the drawers in the freezer compartment

### **Fruit and vegetable drawer**

The fruit and vegetable drawer ensures the best storage conditions for fresh food, avoiding any contamination

### **Inverter compressor**

Inverter compressor reduces noise and vibration levels for a quiet and comfortable kitchen environment

Inverter compressor technology offers significant advantages for refrigeration systems, improving both performance and efficiency. Better temperature control ensures a more stable and constant indoor environment, preserving the freshness of food. This technology also results in reduced energy consumption, as the compressor adjusts its speed according to cooling needs.

---

## Manual Ice Maker

Manual ice maker to manually adjust the amount of ice produced according to personal requirements

## External display

External display for simple and intuitive control with quick access to information