

FQ960P



Product Family	Refrigerator
Installation	Free standing
Category	4 Doors
Sistema Total No - Frost	Total
Cooling type	Total No Frost - Triple Cooling system
Defrost	Automatic
EAN code	8017709217662



Aesthetics

Aesthetic	Victoria	Side material	Steel
Colour	Cream	Side colour	Cream
Design	Flat	Logo	Applied
Material	Metal sheet	Display	7 segments
Handle	External	Display position	
Handle colour	Chrome	Alternative colours available	Pastel blue, Nero Lucido
Logo colour	Chrome	Available colours	FQ960N, FQ960PB

Refrigerator compartment features

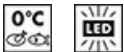

No. of adjustable shelves	2	Bottle shelf	Yes
Number of fruit and vegetables drawers	2	Type of crisper/vegetable drawers cover	Glass
Shelves material	Glass	Life Plus zone-0°C	Yes
Type of crisper/vegetable drawers cover	Standard	Internal light in fridge	Yes
Crisper Cover	Yes	Type of internal light (fridge)	LED

Refrigerator Inner Door

No. of door shelves with transparent cover	2	No. of bottle shelves	2
---	---	------------------------------	---

Number of adjustable door shelves 2

Bottle shelves with wire support Yes

Other Refrigerator features



Accessories 2 sliders, Egg tray
 Natural Plus Blu Light Yes
 MultiFlow Yes

Fan Yes
 Ionizer Yes

Freezer compartment features

Number of drawers 5
 No. of shelves 1

Type of shelves Plastic

Other Freezer features



Fast freezing compartment Yes

Other technical features



Functions display	Holiday, Ionizer, MultiZone, ECO
MultiZone	Yes
Fast freezing button	Yes
Water network connection	
Temperature alarm lamp	Yes
Door open alarm	Yes
Temperature Alarm	Yes
Type of temperature control	Electronic
No. of compressors	1
Refrigerant gas type	R600a
Type of compressor	Standard
Refrigerant Quantity (g)	68 g
Foam agent	Cyclopentane

Performance / Energy Label - Reg. 2019

Airborne acoustical noise emissions 46 dB(A) re 1 pW

Climate class SN, N, ST, T

Electrical Connection







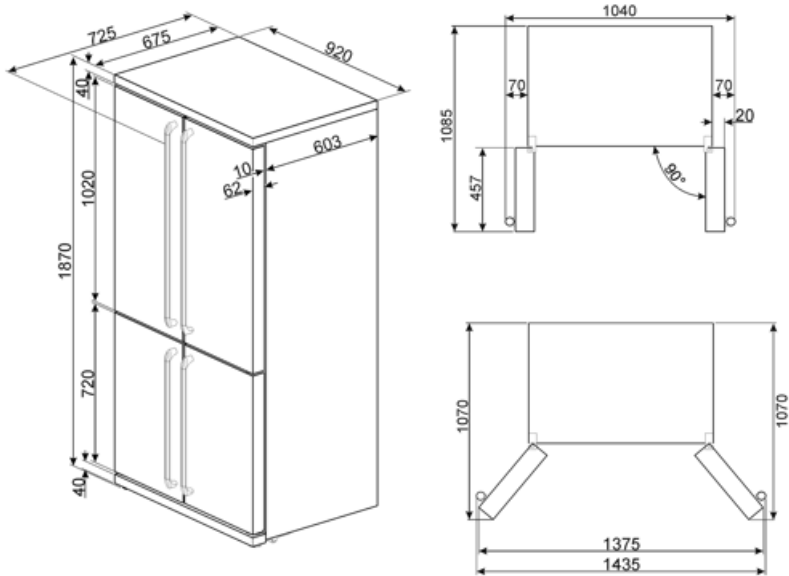





Electrical connection rating	190 W	Frequency (Hz)	50 Hz
Current	0,95 A	Power supply cable length	190 cm
Voltage (V)	220-240 V	Plug	(F;E) Schuko

Logistic Information

Width	920 mm	Product width with maximum doors opening	1435 mm
Depth without handle	725 mm	Product depth with handle	725 mm
Height	1870 mm	Product depth with doors open at 90°	1085 mm



Symbols glossary

 <p>4 stars freezing compartment for better food preservation.</p>	 <p>A+: Energy efficiency class A+ helps to save up to 10% energy compared to class A. Maximum performance with minimum consumption is guaranteed.</p>
 <p>Smeg Active Ion system improves the quality of the air inside the cell. Thanks to the generation of negatively charged ions released inside the fridge Active Ion system neutralizes unpleasant dust.</p>	 <p>The automatic defrost system works by automatically defrosting at regular intervals eliminating the need to defrost altogether.</p>
 <p>Economical mode: Analyzes fridge functioning during the activation and optimizes the operating cycle in order to reduce power consumption.</p>	 <p>Ventilated: Forced distribution of cold air in the refrigerator compartment, which allows even temperature distribution within the fridge.</p>
 <p>Fast freezing: The fast freezing function brings the temperature of the compartment down when activated a few hours prior to usage.</p>	 <p>Power saving mode: The power saving mode allows you to disable the refrigerator and keep the freezer working.</p>
 <p>LED interior lighting: is a more energy efficient and long lasting way of illuminating the interior of the appliance.</p>	 <p>Life Plus 0°C: The temperature in the Lifeplus compartments is kept at 0°C, which preserves fresh meat and fish longer.</p>
 <p>Multiflow Cooling System: the Multiflow ventilation system allows an even distribution of cool air around the fridge cabinet.</p>	 <p>Multizone: Multizone compartment can be used as a refrigerator or a freezer compartment. Depending on your needs and eating habits, you can select settings, program the temperature using.</p>
 <p>Natural Plus Blu Light: This unique Natural Plus Blu Light system works with nature to increase the storage time of fruit and vegetables.</p>	