

FQ960PB5



Product familie	Koelkast
Installatie	Vrijstaand
Categorie	Koel-vriescombinatie met 4 deuren
Referentie breedte	Meer dan 80 cm
No Frost systeem	Totaal No-Frost
Type koelen	Dubbel koelsysteem
Ontdooien	Automatisch ontdooien
EAN-code	8017709297480



Design



Design	Victoria	Materiaal zijwanden	Staal
Kleur	Pastelblauw	Kleur zijkanten	Pastelblauw
Design	Plat	Logo	Geassembleerd
Materiaal deur	Plaatstaal	Kleur profielen binnenzijde	Zilver
Handgreep	Extern	Kleur profielen laden	Zilver
Type handgreep	Vast	Kleur profiel glazen leggers	Chroom
Kleur handgreep	Chroom	Display	LED
Kleur logo	Chroom	Positie display	Binnen (bovenzijde)

Uitrusting koelkast



Aantal verstelbare leggers	2	Type afdekplaat groente-/fruitlade	Glas
Aantal groente-/fruitlades	2	Life Plus zone 0°C	Ja
Shelves material	Glas	Binnenverlichting koelkast	Ja
Type afdekplaat groente-/fruitlade	Standaard	Type binnenverlichting koelkast	LED
Afdekplaat groentenlade	Ja		

Binnendeur koelkast

Aantal binnendeurcompartimenten met transparante deksel	2	Aantal flessenhouders	2
Aantal verstelbare binnendeurcompartimenten	2		

Overige features koelkast



Accessoires	Eierhouder	Ventilator	Ja
Natural Plus Blue Light	Ja	Active Ion technology	Ja
MultiFlow	Ja		

Uitrusting vriezer

Aantal lades	3	Type leggers	Glas
Aantal legplanken	2		

Overige features vriezer



Snel-vriescompartiment Ja

Overige technische eigenschappen



Display functies	Snel-vriesfunctie, Snel-koelfunctie
Snel-vriestoets	Ja
Alarm open deur	Ja
Type temperatuurcontrole	Elektronisch
Aantal compressoren	1
Type koelgas	R600a
Type compressor	Variabele toeren
Hoeveelheid koelmiddel	72 g
Schuimmiddel	Cyclopentaan

Prestaties/Energie label - Reg. 2019



Annual energy consumption	415 kWh/jaar	Geluidsniveau	39 dB(A) re 1 pW
Energie-efficiëntieklasse	F	Conserveringsduur zonder stroom	10 h
Emissieklasse voor akoestisch luchtgeluid	C	4 star - Freezing capacity	4,6 kg/24h
Totaal netto volume	581 l	Freezer (4-star) (1) - Freezing capacity	-18 kg/24h
Netto inhoud vriesgedeelte	196 l		

Netto inhoud koelgedeeltes	385 l	Klimaatklasse EEI	SN, N, ST, T 124 %
-----------------------------------	-------	--------------------------	-----------------------

Elektrische aansluiting







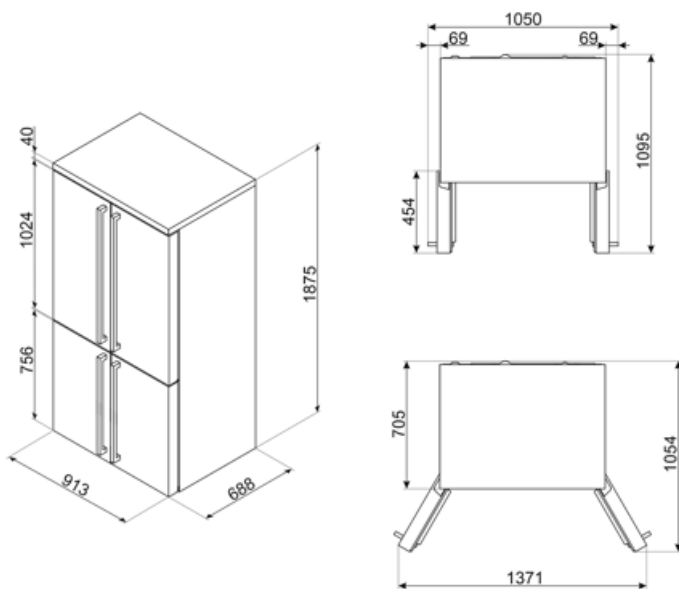





Nominale aansluitwaarde	200 W	Frequentie (Hz)	50 Hz
Stroom (A)	0,8 A	Lengte stroomkabel	240 cm
Spanning (V)	220-240 V	Stekker	(F;E) Schuko

Logistieke informatie

Breedte product (mm)	915 mm	Product breedte met maximale deuropening	1435 mm
Diepte zonder handvat en spacer	705 mm	Diepte toestel met handvat	725 mm
Maximum hoogte	1870 mm	Diepte toestel met deuren open 90°	1085 mm



Symbols glossary

 <p>4 stars freezing compartment for better food preservation.</p>	 <p>Smeg Active Ion system improves the quality of the air inside the cell. Thanks to the generation of negatively charged ions released inside the fridge Active Ion system neutralizes unpleasant dust.</p>
 <p>A+: Energy efficiency class A+ helps to save up to 10% energy compared to class A. Maximum performance with minimum consumption is guaranteed.</p>	 <p>The automatic defrost system works by automatically defrosting at regular intervals eliminating the need to defrost altogether.</p>
 <p>LED display: to show programmes, functions and options selected and the time to the end of the cycle.</p>	 <p>Geventileerd: een geforceerde verdeling van koude lucht in het koelkast compartiment, die een gelijke temperatuurverdeling verzekert in de koelkast.</p>
 <p>Fast freezing: The fast freezing function brings the temperature of the compartment down when activated a few hours prior to usage.</p>	 <p>LED interior lighting: is a more energy efficient and long lasting way of illuminating the interior of the appliance.</p>
 <p>Life Plus 0°C: The temperature in the Lifeplus compartments is kept at 0°C, which preserves fresh meat and fish longer.</p>	 <p>De evolutie van Smeg vaatwassers naar meer intelligente en milieuvriendelijke modellen heeft ertoe geleid om de inverter technologie te gebruiken, die een significante energie- en geluidsbesparing met zich meebrengt.</p>
 <p>Multiflow Cooling System: the Multiflow ventilation system allows an even distribution of cool air around the fridge cabinet.</p>	 <p>Natural Plus Blue Light: Dit unieke Natural Plus Blue Light-systeem verlengt de bewaartijd van groenten en fruit</p>
 <p>Energie-efficiëntieklasse</p>	