

# FQ960PB6



Product Family	Refrigerator
Installation	Free Standing
Category	4 Doors
Reference width	Higher than 80
Reference height	160 - 200
Sistema Total No - Frost	Total
Cooling type	Total sem geada - Sistema de arrefecimento duplo
Defrost	Automatic
Reversible door	No
EAN code	8017709341527



## Aesthetics



Aesthetic	Victoria	Side colour	Pastel blue
Colour	Pastel blue	Logotipo	Logotipo aplicado
Design	Flat	Cor do perfil das prateleiras da porta	Silver
Material	Metal sheet	Cor do perfil das gavetas	Silver
Handle kit to be ordered separately	No	Cor do perfil da prateleira de vidro	Chrome
Handle	External	Display	LED
Handle type	Fixed	Mostrar porções	Interno (no Topo)
Handle colour	Chrome	Dispenser	No
Logo colour	Chrome	Water Filter	No
Side material	Steel	HomeBar	No

## Refrigerator compartment features



No. of adjustable shelves	2	Bottle shelf	No
Number of fruit and vegetables drawers	2	Type of crisper/vegetable drawers cover	Glass
Type of adjustable shelves	Glass	Life Plus zone-0°C	Yes
		Internal light in fridge	Yes

Type of crisper/vegetable drawers cover	Standard	Type of internal light (fridge)	LED
Crisper Cover	Yes		

## Refrigerator Inner Door

No. of door shelves with transparent cover	2	No. of bottle shelves	2
Number of adjustable door shelves	2	Bottle shelves with wire support	No
Adjustable door shelves with wire support	No		

## Other Refrigerator features



Accessories	Egg tray	Fan	Yes
Natural Plus Blu Light	Yes	Ionizer	No
MultiFlow	Yes	Filtro de odor antibacteriano	No

## Freezer compartment features

Number of drawers	4	Internal light in freezer	No
No. of shelves	2	Type of shelves	Glass

## Freezer Inner Door

Pizza box	No
-----------	----

## Other Freezer features



Manual ice maker	No	Fast freezing compartment	Yes
Ice maker	No	Ice tray shelf	No

## Other technical features

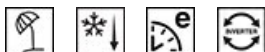

Functions display	Holiday, Fast freezing, Fast cooling, ECO
MultiZone	No
Fast freezing button	Yes
Ligação à rede de água	No
Door open alarm	Yes

Antibacterial Gasket	No
Type of temperature control	Electronic
No. of compressors	1
Refrigerant gas type	R600a
Type of compressor	Inverter
Refrigerant Quantity (gr)	62 g
Espuma expansiva de isolamento	Ciclopentano

## Etiqueta de Desempenho / Energia - Reg. 2019







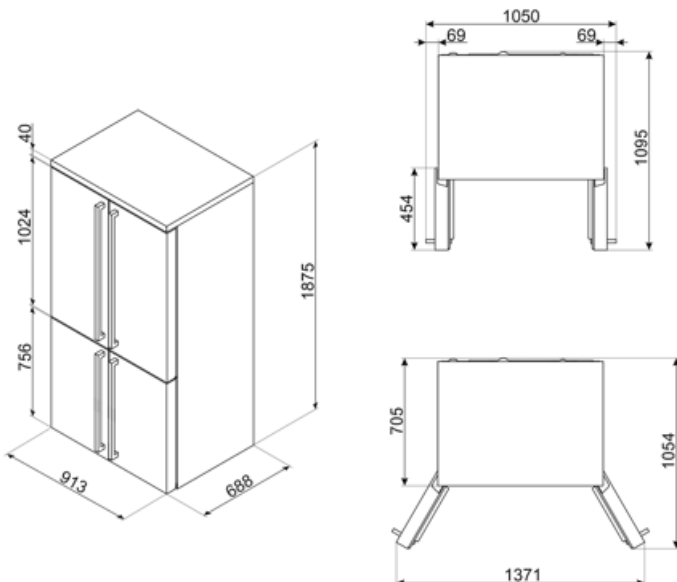





			
Consumo de energia anual	338 kWh/a	Airborne acoustical noise emissions	37 dB(A) re 1 pW
Classe de eficiência energética	E	Autonomia de conservação sem energia elétrica	10 h
Classe de emissão de ruído acústico aerotransportado	C	4 estrelas - Capacidade de congelamento	9 Kg/24h
Volume líquido total	572 l	4 estrelas - Capacidade de congelamento 1	-18 Kg/24h
Soma dos volumes do(s) compartimento(s) congelado(s)	196 l	Classe climática	SN, N, ST, T
Soma dos volumes do(s) compartimento(s) refrigerado(s) e do(s) compartimento(s) não congelado(s)	376 l	EEl	100 %

## Electrical Connection

Plug	(F;E) Schuko	Voltage (V)	220-240 V
Electrical connection rating	200 W	Frequency (Hz)	50 Hz
Current	1,2 A	Power supply cable length	240 cm



## Symbols glossary

-  Compartimento de congelamento de 4 estrelas para uma melhor preservação dos alimentos.
-  Classe de eficiência energética E.
-  Modo económico: Analisa o funcionamento da geladeira durante a ativação e otimiza o ciclo de funcionamento, a fim de reduzir o consumo de energia.
-  CONGELAMENTO RÁPIDO: A função de congelamento rápido reduz a temperatura do compartimento quando ativado algumas horas antes do uso.
-  Iluminação interior LED: é uma forma mais eficiente em termos energéticos e duradoura de iluminar o interior do aparelho.
-  Tecnologia do inversor: A evolução dos secadores Smeg para modelos mais inteligentes e ambientalmente sustentáveis levou à escolha do uso da tecnologia do inversor com bombas de calor, o que reduz significativamente o consumo de energia.
-  Natural Plus Blu Light: Este exclusivo sistema Natural Plus Blu Light trabalha com a natureza para aumentar o tempo de armazenamento de frutas e legumes.
-  O sistema de descongelamento automático funciona descongelando automaticamente em intervalos regulares, eliminando a necessidade de descongelar completamente.
-  Display LED: para mostrar os programas, funções e opções selecionadas e o tempo até ao final do ciclo.
-  Ventilado: Distribuição forçada de ar frio no compartimento da geladeira, o que permite uma distribuição uniforme da temperatura dentro da geladeira.
-  Modo de economia de energia: O modo de economia de energia permite-lhe desativar a geladeira e manter o congelador a funcionar.
-  Life Plus 0°C: A temperatura nos compartimentos Lifeplus é mantida a 0°C, o que preserva a carne fresca e o peixe por mais tempo.
-  Ar mais: mantém a comida mais fresca por mais tempo.

## Benefit (TT)

---

### **No-Frost system**

The No Frost system prevents the formation of ice and contributes to better preservation of food in the refrigerator

### **Natural Plus Blue Light**

The Natural plus Blue light system extends the shelf life of fruit and vegetables while preserving their organoleptic properties

### **Plastic multiflow system**

The Multiflow system ensures even distribution of cold air inside the refrigerator

### **Fan**

The fan contributes to an even distribution of air inside the refrigerator

### **Refrigerant gas R600a**

Environmentally friendly R600a refrigerant gas contributes to rapid cooling with lower energy consumption

### **Climate class**

Climatic class SN-T makes the appliance suitable for working at room temperature between 10 °C and 43 °C (50 °F ~ 109 °F)

### **External handle**

The external handle ensures practicality and ease of use of the refrigerator

### **Life Plus 0°**

Temperature-controlled Life Plus compartment for optimal storage of specific food categories

### **Refrigerator Internal lighting**

Interior lighting for perfect visibility of shelves in the refrigerator compartment

### **Fruit and vegetable drawer**

The fruit and vegetable drawer ensures the best storage conditions for fresh food, avoiding any contamination

### **Inverter compressor**

Inverter compressor reduces noise and vibration levels for a quiet and comfortable kitchen environment

Inverter compressor technology offers significant advantages for refrigeration systems, improving both performance and efficiency. Better temperature control ensures a more stable and constant indoor environment, preserving the freshness of food. This technology also results in reduced energy consumption, as the compressor adjusts its speed according to cooling needs.

### **Internal display**

Internal display for targeted temperature control and a clean, minimalist design