

# FQI48XD



Product familie	Koelkast
Installatie	Vrijstaand
Categorie	Koel-vriescombinatie met 4 deuren
Referentie breedte	Meer dan 80 cm cm
Referentie hoogte	160 - 200 cm cm
No Frost systeem	Ja
Type koelen	No Frost
Ontdooien	Automatisch ontdooien
Type scharnier	Standaard
EAN-code	8017709346508



## Design



Design	Universeel	Kleur logo	Chroom
Kleur	Inox Look	Materiaal zijwanden	Staal
Design	Plat	Kleur zijkanten	Antraciet
Afwerking	Fingerproof	Logo	Geassembleerd
Materiaal deur	Plaatstaal	Kleur profielen binnenzijde	Zilver
Type inox	Vingervlekvrij	Kleur profielen laden	Zilver
Handgreep	Geïntegreerd	Kleur profiel glazen leggers	Zilver
Type handgreep	Vast	Display	LED
Kleur handgreep	Zwart	Positie display	Esterno (su porta)

## Uitrusting koelkast



Number of compartments	2	Type afdekplaat groente-/fruitlade	Glas
Compartment types	Low temperature compartment, Fruit and vegetable compartment	Aantal lampen	2
Aantal verstelbare leggers	2	Convertible temperature drawer	No
Aantal groente-/fruitlades	1	Low temperature compartment	Ja
Shelves material	Glas	Binnenverlichting koelkast	Ja
		Type binnenverlichting koelkast	LED

Type afdekplaat groente-/fruitlade	Standaard
Afdekplaat groentenlade	Ja

## Binnendeur koelkast

Aantal verstelbare binnendeurcompartimenten	4	Aantal flessenhouders	2
---------------------------------------------	---	-----------------------	---

## Overige features koelkast



Humidity Control	Yes, manual	MultiFlow	Metal
Accessoires	Flessenblokkering, Eierhouder	Anti bacteriële geurfilter	Ja

## Uitrusting vriezer

Aantal lades	4	Type leggers	Glas
Aantal legplanken	1		

## Overige features vriezer



Accessoires	Ijsmaker (manueel)	Snel-vriescompartiment	Ja
Ice maker	Manueel ontdooien		

## Overige technische eigenschappen



Display functies	Vakantiefunctie, Snel-vriesfunctie, Snel-koelfunctie, ECO, Kinderbeveiliging, Cooling timer
Snel-vriestoets	Ja
Alarm open deur	Ja
Type temperatuurcontrole	Elektronisch
Aantal compressoren	1
Type koelgas	R600a
Type compressor	Variabele toeren
Hoeveelheid koelmiddel	62 g
Schuimmiddel	Cyclopentaan

## Prestaties/Energie label - Reg. 2019



Geluidsniveau	39 dB(A) re 1 pW
---------------	------------------

<b>Annual energy consumption</b>	244 kWh/jaar	<b>Conserveringsduur zonder stroom</b>	10.8 h
<b>Energie-efficiëntieklasse</b>	D	<b>4 star - Freezing capacity</b>	8.7 kg/24h
<b>Emissieklasse voor akoestisch luchtgeluid</b>	C	<b>Klimaatklasse</b>	SN, T
<b>Totaal netto volume</b>	488 l	<b>EEL</b>	80 %
<b>Netto inhoud vriesgedeelte</b>	166 l		
<b>Netto inhoud koelgedeeltes</b>	322 l		

## Elektrische aansluiting

<b>Nominale aansluitwaarde</b>	206 W	<b>Frequentie (Hz)</b>	50 Hz
<b>Stroom (A)</b>	1 A	<b>Lengte stroomkabel</b>	250 cm
<b>Spanning (V)</b>	220-240 V	<b>Stekker</b>	(F;E) Schuko

## Logistieke informatie

<b>Breedte product (mm)</b>	840 mm	<b>Maximum hoogte</b>	1790 mm
<b>Diepte zonder handvat en spacer</b>	690 mm		

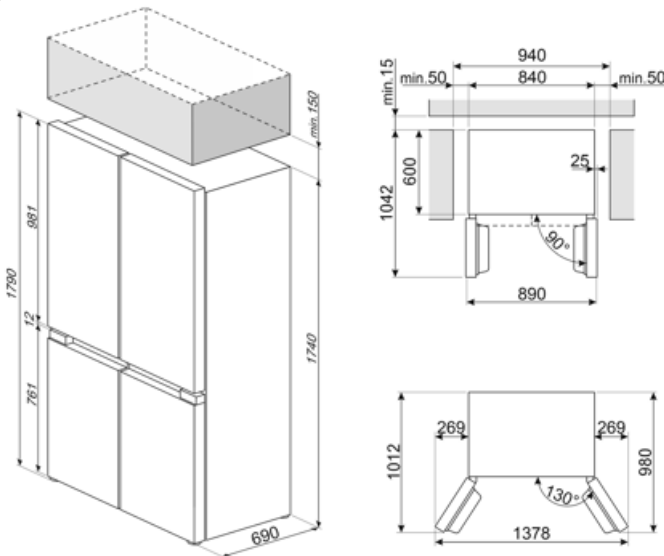

---

## Alternative products











---



**FQI48KD**

Dark Grey Inox Look

## Symbols glossary

- |                                                                                    |                                                                                                                                                                                                     |                                                                                   |                                                                                                                                                                                                                          |
|------------------------------------------------------------------------------------|-----------------------------------------------------------------------------------------------------------------------------------------------------------------------------------------------------|-----------------------------------------------------------------------------------|--------------------------------------------------------------------------------------------------------------------------------------------------------------------------------------------------------------------------|
|    | The automatic defrost system works by automatically defrosting at regular intervals eliminating the need to defrost altogether.                                                                     |  | Sommige modellen zijn voorzien van een functie om het programma/de cyclus te blokkeren zodat het niet per ongeluk kan aangepast worden.                                                                                  |
|    | Energie-efficiëntieklasse                                                                                                                                                                           |  | LED display: to show programmes, functions and options selected and the time to the end of the cycle.                                                                                                                    |
|    | Economical mode: Analyzes fridge functioning during the activation and optimizes the operating cycle in order to reduce power consumption.                                                          |  | Fast freezing: The fast freezing function brings the temperature of the compartment down when activated a few hours prior to usage.                                                                                      |
|    | Fingerprint proof stainless steel: Fingerprint proof stainless steel keeps stainless steel looking as good as new.                                                                                  |  | Power saving mode: The power saving mode allows you to disable the refrigerator and keep the freezer working.                                                                                                            |
|    | LED interior lighting: is a more energy efficient and long lasting way of illuminating the interior of the appliance.                                                                               |  | De evolutie van Smeg vaatwassers naar meer intelligente en milieuvriendelijke modellen heeft ertoe geleid om de inverter technologie te gebruiken, die een significante energie- en geluidsbesparing met zich meebrengt. |
|  | Multiflow Cooling System: the Multiflow ventilation system allows an even distribution of cool air around the fridge cabinet. The stainless steel panel gives a more premium look to the appliance. |                                                                                   |                                                                                                                                                                                                                          |