

FQI48XE



Product Family	Refrigerator
Installation	Free Standing
Category	4 Doors
Reference width	Higher than 80
Reference height	160 - 200
Sistema Total No - Frost	Total
Cooling type	Total sem geada - Sistema de arrefecimento duplo
Defrost	Automatic
Hinge type	Standard
EAN code	8017709346515



Aesthetics



Aesthetic	Universal	Side material	Steel
Colour	Pet Inox Look	Side colour	Dark grey
Acabamento	Anti-dedadas	Logotipo	Logotipo aplicado
Design	Flat	Cor do perfil das prateleiras da porta	Silver
Material	Metal sheet	Cor do perfil das gavetas	Silver
Door steel type	Finger proof	Cor do perfil da prateleira de vidro	Silver
Handle kit to be ordered separately	No	Display	LED
Handle	Integrated	Mostrar porções	Externo (na porta)
Handle type	Fixed	Dispenser	No
Handle colour	Black	Water Filter	No
Logo colour	Chrome	HomeBar	No

Refrigerator compartment features



No. of adjustable shelves	2	Nº de lâmpadas	2
Number of fruit and vegetables drawers	1	Life Plus zone-0°C	No
Type of adjustable shelves	Glass	Convertible temperature drawer	No
		Compartimento baixa temperatura	Yes
		Internal light in fridge	Yes
		Type of internal light (fridge)	LED

Type of crisper/vegetable drawers cover Standard

Crisper Cover Yes

Bottle shelf No

Type of crisper/vegetable drawers cover Glass

Refrigerator Inner Door

Number of adjustable door shelves 4

Adjustable door shelves with wire support No

No. of bottle shelves 2

Bottle shelves with wire support No

Other Refrigerator features



Humidity Control Yes

Accessories Bottle holder, Egg tray

Natural Plus Blu Light No

MultiFlow Yes

Fan No

Ionizer No

Tecnologia de titânio No

Filtro de odor antibacteriano Yes

Freezer compartment features

Number of drawers 4

No. of shelves 1

Internal light in freezer No

Type of shelves Glass

Other Freezer features



Accessories manual ice-maker

Manual ice maker Yes

Ice maker Manual

Fast freezing compartment Yes

Ice tray shelf No

Other technical features



Functions display Holiday, Fast freezing, Fast cooling, ECO, Control lock, Cooling timer

MultiZone No

Fast freezing button Yes

Ligação à rede de água No

Door open alarm Yes

Type of temperature control	Electronic
No. of compressors	1
Refrigerant gas type	R600a
Type of compressor	Inverter
Espuma expansiva de isolamento	Ciclopentano

Etiqueta de Desempenho / Energia - Reg. 2019







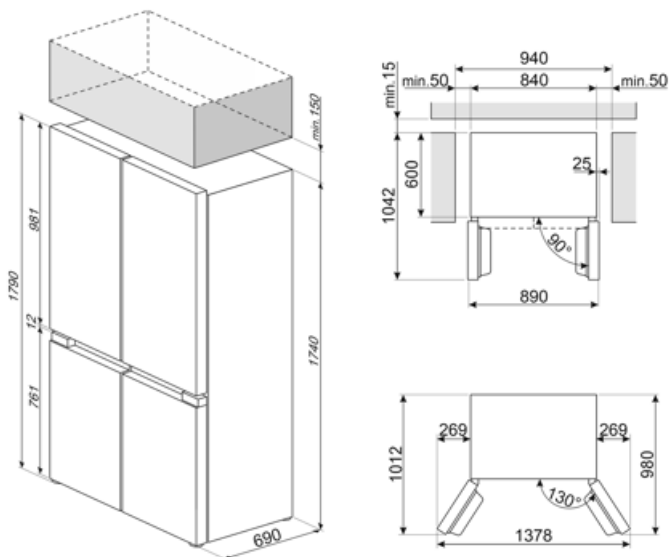



			
Consumo de energia anual	305 kWh/a	Airborne acoustical noise emissions	39 dB(A) re 1 pW
Classe de eficiência energética	E	Autonomia de conservação sem energia elétrica	10.8 h
Classe de emissão de ruído acústico aerotransportado	C	4 estrelas - Capacidade de congelamento	8.7 Kg/24h
Volume líquido total	488 l	Classe climática	SN, T
Soma dos volumes do(s) compartimento(s) congelado(s)	166 l	EI	100 %
Soma dos volumes do(s) compartimento(s) refrigerado(s) e do(s) compartimento(s) não congelado(s)	322 l		

Electrical Connection

Plug	(F;E) Schuko	Voltage (V)	220-240 V
Electrical connection rating	206 W	Frequency (Hz)	50 Hz
Current	1.00 A	Power supply cable length	250 cm



Symbols glossary

- | | | | |
|--|---|---|--|
|  | O sistema de descongelamento automático funciona descongelando automaticamente em intervalos regulares, eliminando a necessidade de descongelar completamente. |  | Bloqueio para crianças: alguns modelos estão equipados com um dispositivo para bloquear o programa/ciclo para que não possa ser acidentalmente alterado. |
|  | Display LED: para mostrar os programas, funções e opções selecionadas e o tempo até ao final do ciclo. |  | Modo económico: Analisa o funcionamento da geladeira durante a ativação e otimiza o ciclo de funcionamento, a fim de reduzir o consumo de energia. |
|  | CONGELAMENTO RÁPIDO: A função de congelamento rápido reduz a temperatura do compartimento quando ativado algumas horas antes do uso. |  | Aço inoxidável à prova de dedadas: O aço inoxidável à prova de dedadas mantém o aço inoxidável com um aspeto novo. |
|  | Modo de economia de energia: O modo de economia de energia permite-lhe desativar a geladeira e manter o congelador a funcionar. |  | Iluminação interior LED: é uma forma mais eficiente em termos energéticos e duradoura de iluminar o interior do aparelho. |
|  | Tecnologia do inversor: A evolução dos secadores Smeg para modelos mais inteligentes e ambientalmente sustentáveis levou à escolha do uso da tecnologia do inversor com bombas de calor, o que reduz significativamente o consumo de energia. |  | Ar mais: mantém a comida mais fresca por mais tempo. |
|  | Classe de eficiência energética E. | | |

Benefit (TT)

No-Frost system

The No Frost system prevents the formation of ice and contributes to better preservation of food in the refrigerator

Plastic multiflow system

The Multiflow system ensures even distribution of cold air inside the refrigerator

Refrigerant gas R600a

Environmentally friendly R600a refrigerant gas contributes to rapid cooling with lower energy consumption

Reversible door

Reversible door ensures flexible installation and space optimisation

Refrigerator Internal lighting

Interior lighting for perfect visibility of shelves in the refrigerator compartment

Fruit and vegetable drawer

The fruit and vegetable drawer ensures the best storage conditions for fresh food, avoiding any contamination

Inverter compressor

Inverter compressor reduces noise and vibration levels for a quiet and comfortable kitchen environment

Inverter compressor technology offers significant advantages for refrigeration systems, improving both performance and efficiency. Better temperature control ensures a more stable and constant indoor environment, preserving the freshness of food. This technology also results in reduced energy consumption, as the compressor adjusts its speed according to cooling needs.

Manual Ice Maker

Manual ice maker to manually adjust the amount of ice produced according to personal requirements

External display

External display for simple and intuitive control with quick access to information