

FQI60KD



Product Family	Refrigerator
Installation	Free standing
Category	4 Doors
Reference width	Higher than 80 cm
Reference height	160 - 200 cm
Sistema Total No - Frost	Yes
Cooling type	Total No Frost
Defrost	Automatic
Hinge type	Standard
EAN code	8017709342128



Aesthetics



Aesthetic	Universale	Side material	Steel
Colour	Dark Inox Look	Side colour	Black
Design	Flat	Logo	Applied
Finishing	Fingerproof	Door shelves profile color	Silver
Material	Steel Effect	Drawers profile color	Silver
Handle	Integrated	Color of glass shelf profile	Silver
Handle type	Fixed	Display	LED
Handle colour	Black	Display porition	Esterno (su porta)
Logo colour	Chrome		

Refrigerator compartment features



Number of compartments	3	No. of lights refrigerator compartment	2
Compartment types	Fruit and vegetable compartment, Variable temperature compartment - 3°/0°/3°C	Convertible temperature drawer	Yes
Crisper Cover	Yes	Internal light in fridge	Yes
Type of crisper/vegetable drawers cover	Glass	Type of internal light (fridge)	LED

Refrigerator Inner Door

Number of adjustable door shelves 4

No. of bottle shelves 2

Other Refrigerator features



MultiFlow

Metal

Freezer compartment features

Number of drawers 4

No. of shelves 2

No. of lights freezer compartment 2

Internal light in freezer Yes

Type of internal light (freezer) LED

Type of shelves Plastic

Other Freezer features



Fast freezing compartment

Yes

Other technical features



Functions display

MultiZone

Fast freezing button

Door open alarm

Type of temperature control

No. of compressors

Refrigerant gas type

Type of compressor

Foam agent

Holiday, Fast freezing, Fast cooling, MultiZone, ECO

Yes

Yes

Yes

Electronic

1

R600a

Inverter

Cyclopentane

Performance / Energy Label - Reg. 2019



Annual energy consumption 255 kWh/a

Energy efficiency class D

Airborne acoustical noise emission class C

Total net volume 522 l

Sum of the volumes of the frozen compartment(s) 179 l

Airborne acoustical noise emissions 39 dB(A) re 1 pW

Temperature Rise Time 11 h

4 star - Freezing capacity 13.0 kg/24h

Climate class SN, N, ST

EEL 80 %

Sum of the volumes of the chill compartment(s) and the unfrozen compartment(s) 343 l

Electrical Connection







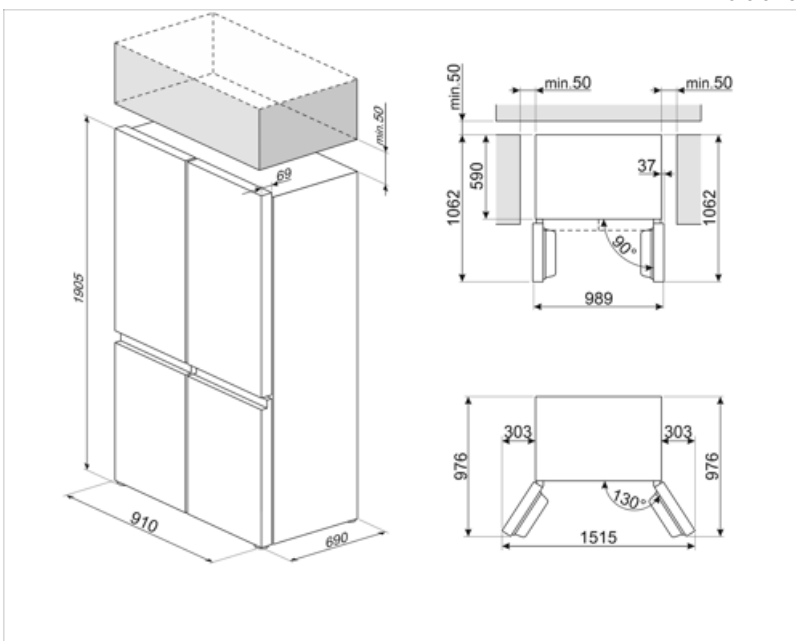



Electrical connection rating	180 W	Frequency (Hz)	50 Hz
Current	1.5 A	Power supply cable length	180 cm
Voltage (V)	220-240 V	Plug	(F;E) Schuko

Logistic Information

Width	910 mm	Product width with maximum doors opening	1515 mm
Depth without handle	690 mm	Product depth with handle	690 mm
Height	1905 mm	Product depth with doors open at 90°	1062 mm



Symbols glossary

- | | | | |
|--|--|---|---|
|  | The automatic defrost system works by automatically defrosting at regular intervals eliminating the need to defrost altogether. |  | LED display: to show programmes, functions and options selected and the time to the end of the cycle. |
|  | Economical mode: Analyzes fridge functioning during the activation and optimizes the operating cycle in order to reduce power consumption. |  | Fast freezing: The fast freezing function brings the temperature of the compartment down when activated a few hours prior to usage. |
|  | Power saving mode: The power saving mode allows you to disable the refrigerator and keep the freezer working. |  | LED interior lighting: is a more energy efficient and long lasting way of illuminating the interior of the appliance. |
|  | Smeg's evolution towards more intelligent and eco-friendly models has led to the choice of Inverter technology, which significantly reduces consumption. |  | Multizone: Multizone compartment can be used as a refrigerator or a freezer compartment. Depending on your needs and eating habits, you can select settings, program the temperature using. |
|  | Energy efficiency class D |  | Multiflow Cooling System: the Multiflow ventilation system allows an even distribution of cool air around the fridge cabinet. The stainless steel panel gives a more premium look to the appliance. |