

FQI60KD



Product Family	Refrigerator
Installation	Free Standing
Category	4 Doors
Reference width	Higher than 80
Reference height	160 - 200
Sistema Total No - Frost	Total
Cooling type	Total No Frost
Defrost	Automatic
Hinge type	Standard
Door opening flush with the wall	No
Slot-in	No
EAN code	8017709342128



Aesthetics



Aesthetic	Universal	Side colour	Silver
Colour	Dark Inox Look	Logotipo	Logotipo aplicado
Acabamento	Anti-dedadas	Cor do perfil das prateleiras da porta	Silver
Design	Flat	Cor do perfil das gavetas	Silver
Material	Steel Effect	Cor do perfil da prateleira de vidro	Silver
Handle kit to be ordered separately	No	Display	LED
Handle	Integrated	Mostrar porções	Externo (na porta)
Handle type	Fixed	Dispenser	No
Handle colour	Black	Water Filter	No
Logo colour	Chrome	HomeBar	No
Side material	Steel		

Refrigerator compartment features



Crisper Cover	Yes	Life Plus zone-0°C	Yes
Bottle shelf	No	Convertible temperature drawer	Yes
Type of crisper/vegetable drawers cover	Glass	Internal light in fridge	Yes
N° de lâmpadas	2	Type of internal light (fridge)	LED

Refrigerator Inner Door

Number of adjustable door shelves	4	No. of bottle shelves	2
Adjustable door shelves with wire support	No	Bottle shelves with wire support	No

Other Refrigerator features



Accessories	No	Ionizer	No
Natural Plus Blu Light	No	Tecnologia de titânio	No
MultiFlow	Metal	Filtro de odor antibacteriano	No
Fan	No	Zona de cuidados biológicos	No

Freezer compartment features

Number of drawers	4	Internal light in freezer	Yes
No. of shelves	2	Type of internal light (freezer)	LED
N° de lâmpadas	2	Type of shelves	Plastic

Freezer Inner Door

Pizza box	No
------------------	----

Other Freezer features



Manual ice maker	No	Fast freezing compartment	Yes
Ice maker	No	Ice tray shelf	No

Other technical features



Functions display	Holiday, Fast freezing, Fast cooling, MultiZone, ECO
MultiZone	Yes
Fast freezing button	Yes
Ligação à rede de água	No
Power on lamp	No
Temperature alarm lamp	No
Door open alarm	Yes
Type of temperature control	Electronic
No. of compressors	1
Refrigerant gas type	R600a

Type of compressor
Espuma expansiva de isolamento

Inverter
Ciclopentano

Etiqueta de Desempenho / Energia - Reg. 2019







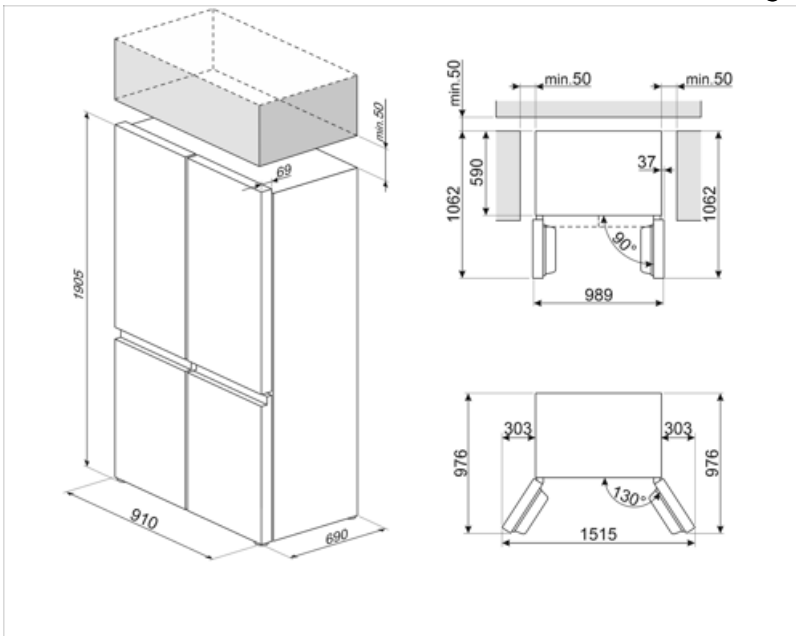



Consumo de energia anual	255 kWh/a	Airborne acoustical noise emissions	39 dB(A) re 1 pW
Classe de eficiência energética	D	Autonomia de conservação sem energia elétrica	11 h
Classe de emissão de ruído acústico aerotransportado	C	4 estrelas - Capacidade de congelamento	13.0 Kg/24h
Volume líquido total	522 l	Classe climática	SN, N, ST
Soma dos volumes do(s) compartimento(s) congelado(s)	179 l	EI	80 %
Soma dos volumes do(s) compartimento(s) refrigerado(s) e do(s) compartimento(s) não congelado(s)	343 l		

Electrical Connection

Plug	(F;E) Schuko	Voltage (V)	220-240 V
Electrical connection rating	180 W	Frequency (Hz)	50 Hz
Current	1,5 A	Power supply cable length	180 cm



Symbols glossary

-  O sistema de descongelamento automático funciona descongelando automaticamente em intervalos regulares, eliminando a necessidade de descongelar completamente.
-  Display LED: para mostrar os programas, funções e opções selecionadas e o tempo até ao final do ciclo.
-  CONGELAMENTO RÁPIDO: A função de congelamento rápido reduz a temperatura do compartimento quando ativado algumas horas antes do uso.
-  Iluminação interior LED: é uma forma mais eficiente em termos energéticos e duradoura de iluminar o interior do aparelho.
-  Tecnologia do inversor: A evolução dos secadores Smeg para modelos mais inteligentes e ambientalmente sustentáveis levou à escolha do uso da tecnologia do inversor com bombas de calor, o que reduz significativamente o consumo de energia.
-  Multiflow Cooling System: the Multiflow ventilation system allows an even distribution of cool air around the fridge cabinet. The stainless steel panel gives a more premium look to the appliance.
-  Classe de eficiência energética D
-  Modo económico: Analisa o funcionamento da geladeira durante a ativação e otimiza o ciclo de funcionamento, a fim de reduzir o consumo de energia.
-  Modo de economia de energia: O modo de economia de energia permite-lhe desativar a geladeira e manter o congelador a funcionar.
-  Life Plus 0°C: A temperatura nos compartimentos Lifeplus é mantida a 0°C, o que preserva a carne fresca e o peixe por mais tempo.
-  Multizona: O compartimento multizona pode ser usado como uma geladeira ou um compartimento congelador. Dependendo das suas necessidades e hábitos alimentares, você pode seleccionar configurações, programar a temperatura.

Benefit (TT)

No-Frost system

The No Frost system prevents the formation of ice and contributes to better preservation of food in the refrigerator

Metallic Multiflow system

The metal Multiflow system ensures an even distribution of cold air inside the refrigerator, which diffuses through an elegant stainless steel panel

A back panel with a series of openings ensures uniform circulation of cold air around each shelf of the refrigerator. This advanced air recirculation system ensures a constant temperature and humidity level, preserving food freshness for longer and helping to reduce food waste significantly

Multizone (variable temperature compartment)

The Multizone system isolates a freezer compartment with adjustable temperature independent of the main compartment, to give maximum storage flexibility

The Multizone compartment can be used both as a freezer and as a refrigerator. Depending on one's needs and eating habits, each user can choose how to set it, programming the temperature via the external display.

Refrigerant gas R600a

Environmentally friendly R600a refrigerant gas contributes to rapid cooling with lower energy consumption

Reversible door

Reversible door ensures flexible installation and space optimisation

Life Plus 0°

Temperature-controlled Life Plus compartment for optimal storage of specific food categories

Refrigerator Internal lighting

Interior lighting for perfect visibility of shelves in the refrigerator compartment

Freezer internal lighting

Interior lighting for perfect visibility of the drawers in the freezer compartment

Inverter compressor

Inverter compressor reduces noise and vibration levels for a quiet and comfortable kitchen environment

Inverter compressor technology offers significant advantages for refrigeration systems, improving both performance and efficiency. Better temperature control ensures a more stable and constant indoor environment, preserving the freshness of food. This technology also results in reduced energy consumption, as the compressor adjusts its speed according to cooling needs.

External display

External display for simple and intuitive control with quick access to information