

# HHSL7845X

Product Family	Hob
Built-in type	Support
Dimensions	83 cm
Power supply	Electric
Type	Induction with integrated hood
Extraction	Extraction
Electronic control	Yes
EAN code	8017709357139
Energy efficiency class ( EEC)	A

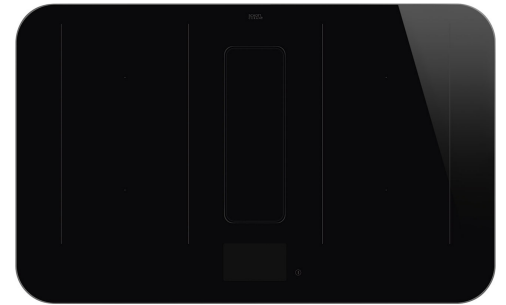

## Aesthetics

Aesthetic	Isola
Serie	Alta Pro
Colour	Black
Perimeter lighting	Yes
Finishing	Glass
Material	Glass
Glass type	Prestige ceramic
Glass edge	Straight edge
Frame	Yes
Frame colour	Stainless Steel
Type of control setting	Vivo Screen
LED colours	TFT
Control knob position	Front
Logo	Silk screen
Serigraphy colour	Grey
Alternative colours available	Black

## Program / Functions

	
No. of induction cook zones	4
Time-setting options	Automatic switch-off
No. of cooking zones with booster	4
No. of Flexible zones	2
Main on/off switch	Yes
Power levels	17
Total no. of cook zones	4

## Options



<b>Multizone Option</b>	Yes	<b>End cooking timer</b>	4
<b>Flexible Zone Type</b>	MultiZone	<b>Pause option</b>	Yes
<b>Worktop Cut-Out</b>	490x750 mm	<b>Minute minder</b>	1
<b>Double Booster</b>	Yes	<b>End of cooking alarm</b>	Yes
<b>Follow Pot</b>	Yes	<b>Residual time indicator</b>	Yes
<b>Pasta function</b>	Yes	<b>Limited Power</b>	Si Advance
<b>Steaming function</b>	Yes	<b>Consumption Mode</b>	
<b>Roasting function</b>	Yes	<b>Limited Power</b>	2400 a 7400 - step 100 W
<b>Auto-boiling Function</b>	Yes	<b>Consumption Mode in W</b>	
<b>Simmering Function</b>	Yes	<b>Showroom Demo Option</b>	Yes
<b>Keep warm automatic function</b>	Yes	<b>Control Lock / Child Safety</b>	Yes
<b>Melting/Low temperature cooking function</b>	Yes	<b>Cleaning option</b>	Yes
		<b>Quick start</b>	Yes
		<b>Rapid level selection</b>	Yes

## Technical Features



Front-left - Induction - Multizone - 2.1 kW - Booster 3.0 kW - Double booster 3.7 kW - 21.0x0.0 cm  
 Rear-left - Induction - Multizone - 2.1 kW - Booster 3.0 kW - Double booster 3.7 kW - 21.0x0.0 cm  
 Front-right - Induction - Multizone - 2.1 kW - Booster 3.0 kW - Double booster 3.7 kW - 21.0x0.0 cm  
 Rear-right - Induction - Multizone - 2.1 kW - Booster 3.0 kW - Double booster 3.7 kW - 21.0x0.0 cm  
 Multizone left - Booster 3.7 kW - 39.0x21.0 cm  
 Multizone right - Booster 3.7 kW - 39.0x21.0 cm

<b>Automatic setting according to pan dimension</b>	Yes	<b>Automatic switch off when overheat</b>	Yes
<b>pan detection</b>	Yes, min. 9 cm	<b>Residual heat indicator</b>	Yes
<b>Permanent Automatic Pot Detection with indication of the relative control</b>	Yes	<b>Protection against accidental start up</b>	Yes

## Accessories included

<b>Regenerable charcoal filter</b>	Yes	<b>Sliding door</b>	Yes
------------------------------------	-----	---------------------	-----

## Electrical Connection

<b>Electrical connection rating (W)</b>	7620 W	<b>Type of electric cable supplied</b>	Yes, Single and Double phase
<b>Current</b>	33 A	<b>Frequency (Hz)</b>	50/60 Hz

Voltage (V)	220-240 V	Power supply cable length	158 cm
Voltage 2 (V)	380-415 V	Plug	Not present

## Controls (hood)

Hood control setting	Touch Capacitive	Display	Yes
Led color	Colori multipli		

## Programs / Functions (hood)

Delay function	Yes	Hood time setting	Delay
No. of speeds	8	Automatic connection between integrated hood and hob	Yes
Intensive speed	2		

## Technical Features (Hood)

Free outlet maximum capacity	650 m <sup>3</sup> /h	Anti-grease filters	Alluminio
Motor power	220 W	Charcoal filters included	YES, regenerable
No. of filters	1	Filter replacement indicator	Yes

## Performance / Energy Label (hood)

Fluid Dynamic Efficiency (FDE)	29.8	Airbourne acoustical A-weighted sound Power Emission at minimum speed (SPEmin)	45 dBA
Fluid Dynamic Efficiency class (FDEC)	A	Airborne acoustical A-weighted sound Power Emission at maximum speed (SPEmax)	64 dBA
Lighting Efficiency (LE)	0.0 lux/W	Airbourne acoustical A-weighted sound power emission at boost speed (SPEboost)	68 dBA
Lighting Efficiency Class (LEC)	NA	Time increase factor (F)	0.9
Grease Filtering Efficiency (GFE)	86 %	Energy Efficiency Index	49.8
Grease Filtering Efficiency Class (GFEC)	B	Measured air flow rate at best efficiency point (Qbep)	368 m <sup>3</sup> /h
Air flow at minumum speed (Qmin)	220 m <sup>3</sup> /h	Measured air pressure at best efficiency point (Pbep)	406 Pa
Air flow at maximum speed (Qmax)	490 m <sup>3</sup> /h	Measured electric power input at best efficiency point (Wbep)	139 W
Air flow at boost speed (Qboost)	620 m <sup>3</sup> /h	Sound power level at highest setting (Lwa)	64 dBA

---

## Speed 1

---

Extraction rate IEC 61591	220 m <sup>3</sup> /h
Noise level IEC 60704-2-13	45 dBA
Pressure	170 Pa
Power	23 W

## Speed 2

---

Extraction rate IEC 61591	260 m <sup>3</sup> /h
Noise level IEC 60704-2-13	49 dBA
Pressure	238 Pa
Power	28 W

## Speed 3

---

Extraction rate IEC 61591	290 m <sup>3</sup> /h
Noise level IEC 60704-2-13	52 dBA
Pressure	295 Pa
Power	32 W

## Speed 4

---

Extraction rate IEC 61591	310 m <sup>3</sup> /h
Noise level IEC 60704-2-13	55 dBA
Pressure	380 Pa
Power	41 W

## Speed 5

---

Extraction rate IEC 61591	330 m <sup>3</sup> /h
Noise level IEC 60704-2-13	58 dBA
Pressure	440 Pa
Power	55 W

## Speed 6

---

Extraction rate IEC 61591	410 m <sup>3</sup> /h
Noise level IEC 60704-2-13	60 dBA
Pressure	500 Pa
Power	70 W

## Speed 7

---

Extraction rate IEC 61591	430 m <sup>3</sup> /h
Noise level IEC 60704-2-13	62 dBA
Pressure	520 Pa
Power	86 W

## Speed 8

---

Extraction rate IEC 61591	490 m <sup>3</sup> /h
Noise level IEC 60704-2-13	64 dBA
Pressure	540 Pa
Power	108 W

## Intensive speed

---

Extraction rate (IEC 61591)	600 m <sup>3</sup> /h
Noise level IEC 60704-2-13	67 dBA
Pressure	550 Pa
Power	198 W

## Intensive Speed 2

---

Extraction rate IEC 61591	620 m <sup>3</sup> /h
Noise level IEC 60704-2-13	68 dBA
Pressure	560 Pa
Power	216 W

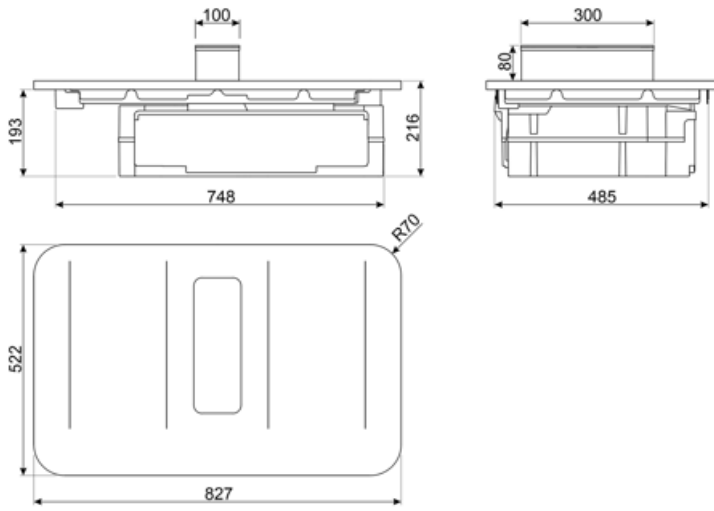

---

## Compatible Accessories

---

### CV45HHSL

Needed for recirculation installations, to be paired with KITRHOB6

### GRILLPLATE

Universal griddle for induction, gas, ceramic and electric hobs. Non-stick surface ideal for cooking meat, cheese and vegetables. Dimensions: 410 x 240 mm.



### FLTRHHSL5



















Anti-odour charcoal filter suitable for Alta Pro HHSL7845X/HHSL7845MB models. The anti-odour filter can be washed and regenerated every 3-4 months, up to a Max. of 8 regeneration cycles. Regeneration procedure: Wash in the dishwasher at a MAX temperature of 70°. Dry in the oven at a MAX temperature of 70° for 2 hours. Each kit contains 1 filter.

### TPKPLATE

Universal plate for induction, gas, ceramic and electric hobs. Non-stick surface ideal for cooking fish, eggs and vegetables. Dimensions: 410 X 240 mm.



## Symbols glossary

 <p>Permanent auto pot detection</p>	 <p>Automatic Boiling function: a sensor confirms once the boiling point has been reached and then an acoustic alert signals that the ingredients can be added, saving time and energy.</p>
 <p>Power booster: option allows the zone to work at full power when very intense cooking is necessary.</p>	 <p>Child lock: some models are fitted with a device to lock the programme/cycle so it cannot be accidentally changed.</p>
 <p>This function allows you to keep cooked food warm without burner it</p>	 <p>Overheat protection: The safety system that automatically turns off the hob in case of overheating of the control unit.</p>
 <p>Melting function, suitable for slowly melting delicate foods such as chocolate or butter.</p>	 <p>Multizone: allows several pans to be used at once, large or small, offering freedom of placement and greater flexibility</p>
 <p>All cooking zones can be reduced to the minimum power level, so the hob can be left unattended for a short period without food overcooking or burning. Then just press again this function, the previously set power levels can be reactivated.</p>	 <p>Quick selection, with one touch cooking begins at the highest level, then automatically reduces after time. Ideal for dishes that require quick boiling and then continued cooking without constant control (eg beef broth).</p>
 <p>Quick Start function: the chosen temperature is reached faster. The heating element works at maximum power until the right temperature is reached.</p>	 <p>Indication of residual heat: After the glass ceramic hob is switched off the residual heat indicator shows which of the heating zones still remains hot. When the temperature drops below 60 ° C, the indicator goes out.</p>
 <p>Simmering function: ideal for long-cooking recipes, preventing food from boiling over or sticking to the pan.</p>	 <p>Time elapsed: shows how long the cooking zone has been in use.</p>
 <p>Timer: All ceramic hobs have a timer which automatically ends cooking after a preset time.</p>	 <p>Min diameter pot detection of 9 cm.</p>
 <p>Possibility to set the maximum power absorption of the hob.</p>	 <p>Additional maximum power level for a better energy consumption</p>
 <p>Possibility to freely move the pot everywhere without turn off the initial settings chosen.</p>	