

# HOBD682D1

Product Family	Hob
Built-in type	Ultra-low profile or Fully Flushed
Dimensions	80 cm
Power supply	Electric
Type	Induction with integrated hood
Extraction	Extraction
Electronic control	Yes
EAN code	8017709298685



## Aesthetics



Aesthetic	Universale
Colour	Black
Finishing	Glass
Material	Glass
Glass type	Ceramic
Glass edge	Straight edge
Pan stands	Cast iron
Type of control setting	Multi Slider
Slider	Yes
Control knob position	Front
Serigraphy colour	Grey

## Programs / Functions



Total no. of cook zones	2
No. of induction cook zones	4
Time-setting options	Automatic Shutdown
No. of cooking zones with booster	4
No. of Flexible zones	2
Main on/off switch	Yes
Power levels	9
Auto-vent 2.0	Si

## Options

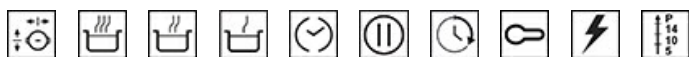

<b>Multizone Option</b>	Yes	<b>Pause option</b>	Yes
<b>Flexible Zone Type</b>	MultiZone	<b>Minute minder</b>	1
<b>Standard cut out</b>	482-483x765-766 mm	<b>End of cooking alarm</b>	Yes
<b>Simmering Function</b>	Yes	<b>Residual time indicator</b>	Yes
<b>Keep warm automatic function</b>	Yes	<b>Control Lock / Child Safety</b>	Yes
<b>Melting/Low temperature cooking function</b>	Yes	<b>Quick start</b>	Yes
<b>End cooking timer</b>	4	<b>Rapid level selection</b>	Yes

## Technical Features



Left - Induction - Multizone - 2.10 kW - Booster 3.70 kW - 23.0x21.0 cm  
 Right - Induction - Multizone - 2.10 kW - Booster 3.70 kW - 23.0x21.0 cm  
 2.10 kW - Booster 3.70 kW - 23.0x21.0 cm  
 2.10 kW - Booster 3.70 kW - 23.0x21.0 cm  
 Multizone left - Booster 3.70 kW - 46.0x21.0 cm  
 Multizone right - Booster 3.70 kW - 46.0x21.0 cm

<b>Automatic setting according to pan dimension</b>	Yes	<b>Automatic switch off when overflow</b>	Yes
<b>pan detection</b>	Yes	<b>Residual heat indicator</b>	Yes
<b>Permanent Automatic Pot Detection with indication of the relative control</b>	Yes	<b>Protection against accidental start up</b>	Yes

## Electrical Connection

<b>Electrical connection rating (W)</b>	7620 W	<b>Type of electric cable</b>	Universal
<b>Current</b>	33 A	<b>Frequency (Hz)</b>	50/60 Hz
<b>Voltage (V)</b>	220-240 V	<b>Power supply cable length</b>	120 cm
<b>Voltage 2 (V)</b>	380-415 V	<b>Terminal box</b>	6 poles

## Controls (hood)

<b>Hood control setting</b>	Touch Capacitive	<b>Display</b>	Yes
<b>Led color</b>	Bianco		

## Programs / Functions (hood)

<b>No. of speeds</b>	8	<b>Other functions</b>	AUTOVENT
<b>Intensive speed</b>	2		

## Technical Features (Hood)

Free outlet maximum capacity	750 m <sup>3</sup> /h	Anti-grease filters	Alluminio
Motor power	220 W	Filter replacement indicator	Yes
No. of filters	1		

## Performance / Energy Label (hood)

Energy efficiency class (EEC)	A+++	Airbourne acoustical A-weighted sound Power Emission at minimum speed (SPEmin)	51 dB(A)
Fluid Dynamic Efficiency (FDE)	40.30	Airborne acoustical A-weighted sound Power Emission at maximum speed (SPEmax)	65 dB(A)
Fluid Dynamic Efficiency class (FDEC)	A	Airbourne acoustical A-weighted sound power emission at boost speed (SPEboost)	72 dB(A)
Lighting Efficiency (LE)	0.0 lux/W	Power Consumption in Off mode (Po)	0.49 W
Lighting Efficiency Class (LEC)	NA	Time increase factor (F)	0.5
Grease Filtering Efficiency (GFE)	85.1 %	Energy Efficiency Index	27.5
Grease Filtering Efficiency Class (GFEC)	B	Measured air flow rate at best efficiency point (Qbep)	359 m <sup>3</sup> /h
Air flow at minumum speed (Qmin)	245 m <sup>3</sup> /h	Measured air pressure at best efficiency point (Pbep)	549 Pa
Air flow at maximum speed (Qmax)	505 m <sup>3</sup> /h	Measured electric power input at best efficiency point (Wbep)	136 W
Air flow at boost speed (Qboost)	700 m <sup>3</sup> /h	Sound power level at highest setting (Lwa)	65 dB(A)

## Electrical Connections (hood)

Frequenza cappa	50-60 Hz
-----------------	----------

### Speed 1

Extraction rate IEC 61591	245 m <sup>3</sup> /h
Noise level IEC 60704-2-13	51 dB(A)
Pressure	290 Pa
Power	35 W

### Speed 2

Extraction rate IEC 61591	285 m <sup>3</sup> /h
Noise level IEC 60704-2-13	55 dB(A)
Pressure	370 Pa
Power	45 W

### Speed 3

Extraction rate IEC 61591	350 m <sup>3</sup> /h
Noise level IEC 60704-2-13	57 dB(A)
Pressure	525 Pa
Power	60 W

### Speed 4

Extraction rate IEC 61591	380 m <sup>3</sup> /h
Noise level IEC 60704-2-13	59 dB(A)
Pressure	530 Pa
Power	75 W

### Speed 5

Extraction rate IEC 61591	410 m <sup>3</sup> /h
Noise level IEC 60704-2-13	62 dB(A)
Pressure	535 Pa
Power	85 W

### Speed 6

Extraction rate IEC 61591	445 m <sup>3</sup> /h
Noise level IEC 60704-2-13	63 dB(A)
Pressure	540 Pa
Power	105 W

### Speed 7

Extraction rate IEC 61591	475 m <sup>3</sup> /h
Noise level IEC 60704-2-13	64 dB(A)
Pressure	545 Pa
Power	115 W

### Speed 8

Extraction rate IEC 61591	505 m <sup>3</sup> /h
Noise level IEC 60704-2-13	65 dB(A)
Pressure	550 Pa
Power	125 W

### Intensive speed

Extraction rate (IEC 61591)	550 m <sup>3</sup> /h
Noise level IEC 60704-2-13	66 dB(A)
Pressure	555 Pa
Power	140 W

### Intensive Speed 2

Extraction rate IEC 61591	700 m <sup>3</sup> /h
Noise level IEC 60704-2-13	72 dB(A)
Pressure	560 Pa
Power	220 W

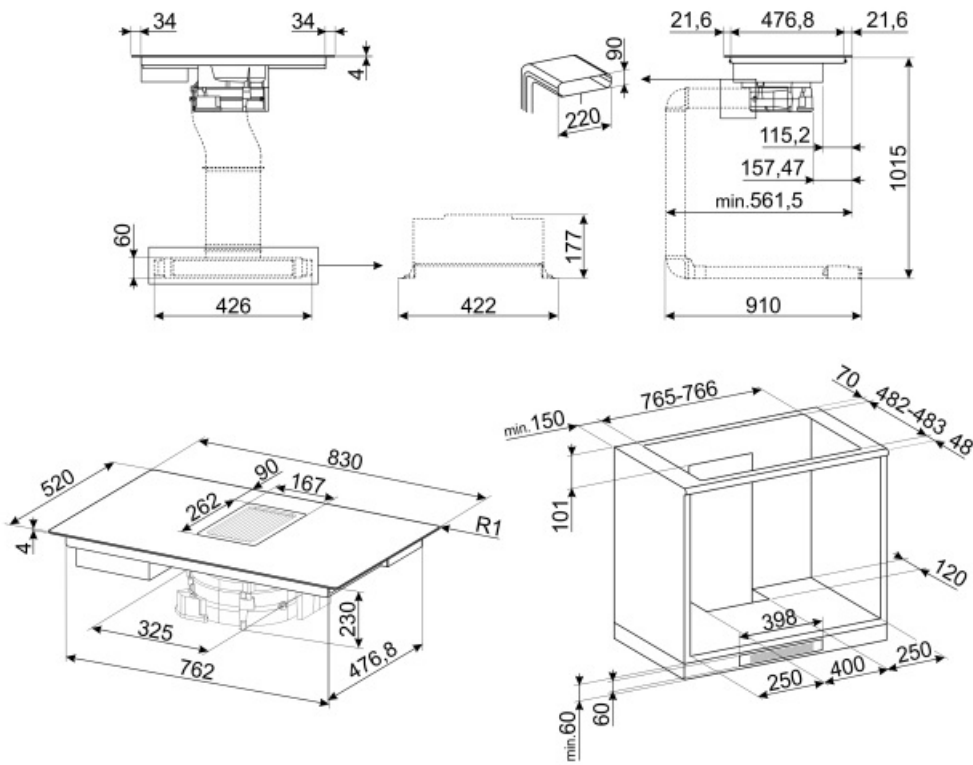

## Not included accessories

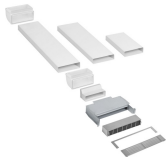

### KITF6HOBD

Recirculating kit for Hobd: tubes + regenerable anti-odor filter + grid in stainless steel with magnetic fix (easy to remove) that fit in a plinth of min. 6 cm



### CON60H

Flat duct connector for tubes 220\*60 mm. It helps to connect more tubes of the kit KITEHOBD4



### GRI60H

Rectangular Louvred grille, external size 246\*80 mm and internal 226\*60\*50 mm



### KITEHOBD4

Filtering kit (lateral outlet) optional for Hobd: tube 1,5 mt and curve



### FLTHOBD

Ceramic Anti Odour Filter regenerable as spare part suitable for Recirculating kit (accessory KITF6HOBD) of the hob with integrated hood models HOBD682D and HOBD682R



### RED60H

Reducer from 90 to 60 mm



### TPK



















Stainless steel grill plate to cook Teppanyaki dishes



### KITEHOBD

Exhaust kit optional for Hobd: tubes for installation in exhaust mode

## Symbols glossary (TT)

 <p>Power booster: option allows the zone to work at full power when very intense cooking is necessary.</p>	 <p>Heavy duty cast iron pan stands: for maximum stability and strength.</p>
 <p>Child lock: some models are fitted with a device to lock the programme/cycle so it cannot be accidentally changed.</p>	 <p>The slider control panel allows you to adjust the power simply by passing your finger across the touch device.</p>
 <p>Keep warm function: Keep warm function keeps the cooked food heated. In this mode the heating zone operates at a minimum capacity for 120 minutes and then turns off automatically.</p>	 <p>Melting function, suitable for slowly melting delicate foods such as chocolate or butter.</p>
 <p>Multizone: allows several pans to be used at once, large or small, offering freedom of placement and greater flexibility</p>	 <p>Overfill protection: The special overfill protection shuts down the stove in the presence of overflow of liquids.</p>
 <p>PAUSE_72dpi</p>	 <p>Quick selection, with one touch cooking begins at the highest level, then automatically reduces after time. Ideal for dishes that require quick boiling and then continued cooking without constant control (eg beef broth).</p>
 <p>Quick Start function: the chosen temperature is reached faster. The heating element works at maximum power until the right temperature is reached.</p>	 <p>Indication of residual heat: After the glass ceramic hob is switched off the residual heat indicator shows which of the heating zones still remains hot. When the temperature drops below 60 ° C, the indicator goes out.</p>
 <p>Simmering function: ideal for long-cooking recipes, preventing food from boiling over or sticking to the pan.</p>	 <p>Time elapsed: shows how long the cooking zone has been in use.</p>
 <p>Timer: All ceramic hobs have a timer which automatically ends cooking after a preset time.</p>	 <p>...</p>
 <p>...</p>	 <p>Premium individual Slider control for each zone</p>