

# K43X

Product family	Hood
Subfamily	Hood
Hood Type	Mounted on oven
Design	Angled
Tecnology	Chimney
Extraction	Recirculation
Electronic control	Yes
Suitable for	Convection ovens 435x320 mm
Material	Stainless steel
Type of steel	Polished
Hood width	60 cm



## Aesthetics

Colour	Stainless steel	Logo	Embossed
Components finishing	Stainless steel		

## Controls

Control setting	Touch control back-lighted White	Led color	White
-----------------	-------------------------------------	-----------	-------

## Technical Features



No. of lights	1	Charcoal filters included	Yes
Light type	LED	No. of filters	1
Light Power	1,1 W	Filter replacement indicator	Yes
Dimmer mode	Yes	Vent outlet	150 mm
Free outlet maximum capacity	670 m <sup>3</sup> /h	Non return valve	Yes
Anti-grease filters	Buffle	Light color temperature scale (K)	4000 K
Motor power	230 W		

## Electrical Connection

Electrical connection rating	232 W	Frequency (Hz)	50-60 Hz
Voltage	220-240 V	Power supply cable length	1500 mm

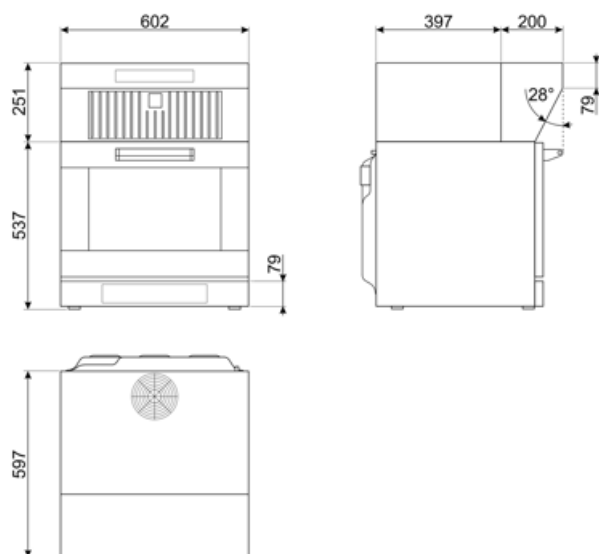

## Logistic Information

---

<b>EAN code</b>	8017709305956	<b>Net weight</b>	11,700 kg
<b>Packed product dimensions (WxDxH)</b>	602x597x251 mm	<b>Gross weight</b>	14,130 kg

---

## Compatible Accessories

---



### FLT6

Round Charcoal filters (kit 2 pieces)



### KITCMNKVX









Chimney Extension in Stainless Steel for hood KV\*series



### KITALLFC

Universal Charcoal filter Stainless Steel AISI 304 The filter can be washed in dishwasher 50 °C (water and suitable detergent) and to dry it put in the oven 180°C 25 minutes

## Symbols glossary

- |  |   |   |   |
|--|---|---|---|
|  | 24h: When selected this function refreshes the air for c. 10 minutes every hour over a 24 hour period, at minimum speed and an imperceptible noise level. |  | Filters: Model has filters to help remove grease from the steam emanating from the pans during cooking.                       |
|  | Switch off automatically: A special setting, to run after the end of cooking for a pre-set time and then switch off automatically.                        |  | Charcoal filters: Extracting through charcoal filters or directly to the exterior lessens strong cooking odours considerably. |
|  | Warning light(s): to advise when filters need changing.   |  | Lights: All cooker hoods feature lights to illuminate the cooking area or add to the ambience of the kitchen.                 |
|  | Intensive/turbo setting: when extra fast extraction is required.  |  | Dimming Lights  |