

K4610X

Product family	Hood
Product family	Hood
Hood Type	Mounted on oven
Design	Angled
Design	Chimney
Extraction	Recirculation
Electronic control	Yes
Suitable for	Combined ovens 5 GN1/1 ; Convection ovens 600x400 mm - GN1/1
Material	Stainless steel
Type of steel	Polished
Hood width	80 cm



Aesthetics

Colour	Stainless steel	Logo	Embossed
Components finishing	Stainless steel		

Controls

Control setting	Touch control back-lighted White	Led colour	White
-----------------	-------------------------------------	------------	-------

Technical Features



No. of lights	1	Charcoal filters included	Yes
Light type	LED	No. of filters	2
Light power	1,1 W	Filter replacement indicator	Yes
Dimmer mode	Yes	Vent outlet	150 mm
Free outlet maximum capacity	900 m ³ /h	Non return valve	Yes
Anti-grease filters	Buffle	Light colour temperature scale (K)	4000 K
Motor power	330 W		

Electrical Connection

Voltage	220-240 V	Power supply cable length	1500 mm
Frequency (Hz)	50-60 Hz		

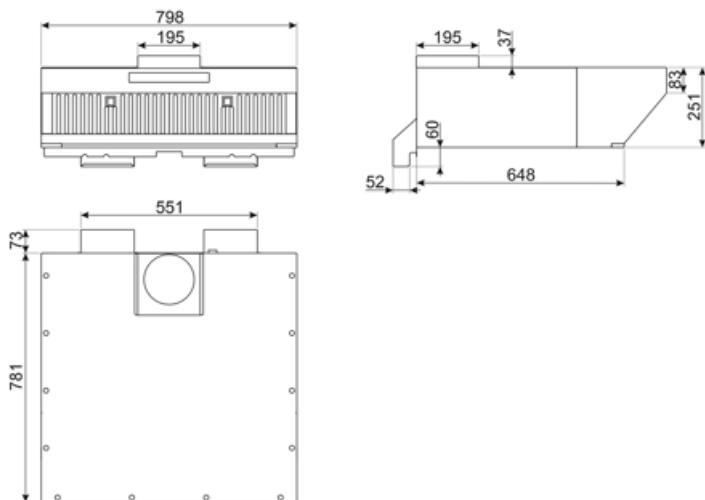

Logistic Information

EAN code	8017709314446	Net weight	19.810 kg
Packed product dimensions (WxDxH)	798x854x251 mm	Gross weight	24.230 kg

Compatible Accessories



FLT6

Round Charcoal filters (kit 2 pieces)



KITCMNKVX









Chimney Extension in Stainless Steel for hood KV*series



KITALLFC

Universal Charcoal filter Stainless Steel AISI 304 The filter can be washed in dishwasher 50 °C (water and suitable detergent) and to dry it put in the oven 180°C 25 minutes

Symbols glossary

- | | | | |
|--|---|---|---|
|  | 24h: When selected this function refreshes the air for c. 10 minutes every hour over a 24 hour period, at minimum speed and an imperceptible noise level. |  | Filters: Model has filters to help remove grease from the steam emanating from the pans during cooking. |
|  | Switch off automatically: A special setting, to run after the end of cooking for a pre-set time and then switch off automatically. |  | Charcoal filters: Extracting through charcoal filters or directly to the exterior lessens strong cooking odours considerably. |
|  | Warning light(s): to advise when filters need changing. |  | Lights: All cooker hoods feature lights to illuminate the cooking area or add to the ambience of the kitchen. |
|  | Intensive/turbo setting: when extra fast extraction is required. |  | Dimmering Lights |